

2002 SXI PRO PARTS DIAGRAM

Generator

E1810

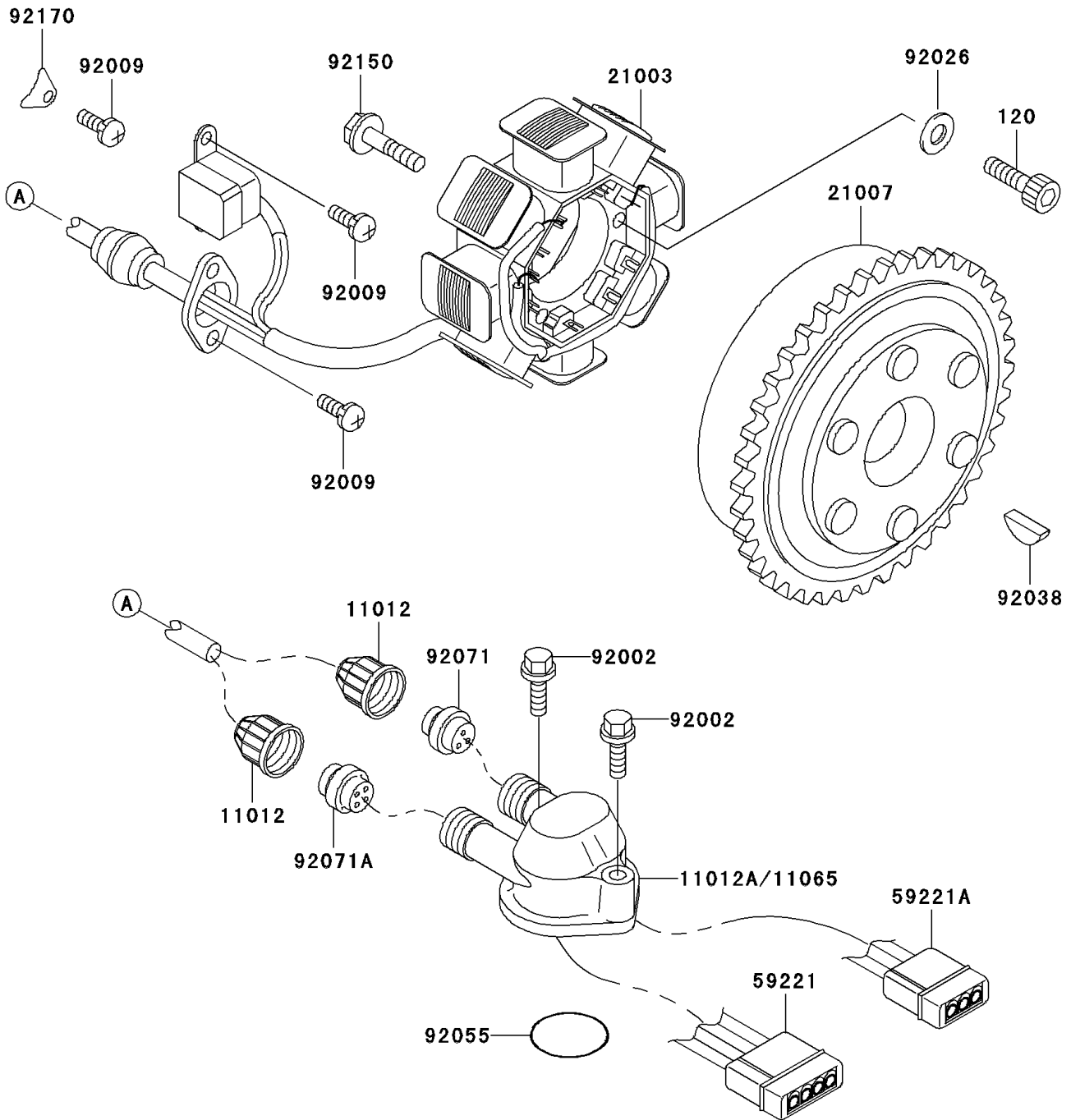

2002 SXI PRO PARTS LIST

Generator

ITEM NAME	PART NUMBER	QUANTITY
BOLT-SOCKET,6X30 (Ref # 120)	120P0630	3
CAP (Ref # 11012)	11012-3005	2
CAP,ELECTRIC CASE (Ref # 11065)	11065-3713	1
STATOR (Ref # 21003)	21003-3732	1
ROTOR,MAGNETO (Ref # 21007)	21007-3713	1
CONNECTOR-CORD (Ref # 59221)	59221-3701	1
CONNECTOR-CORD (Ref # 59221A)	59221-3703	1
BOLT,6X35 (Ref # 92002)	92002-3715	2
SCREW,5X12 (Ref # 92009)	92009-1296	5
SPACER,6.3X12X1.0 (Ref # 92026)	92026-094	3
KEY,WOODRUFF (Ref # 92038)	92038-001	1
RING-O (Ref # 92055)	92055-3706	1
GROMMET (Ref # 92071)	92071-3784	1
GROMMET (Ref # 92071A)	92071-3786	1
BOLT (Ref # 92150)	92150-3843	1
CLAMP,HARNEES (Ref # 92170)	92170-3728	1