

1979 Custom PARTS DIAGRAM

OIL PUMP/OIL FILTER/OIL PAN

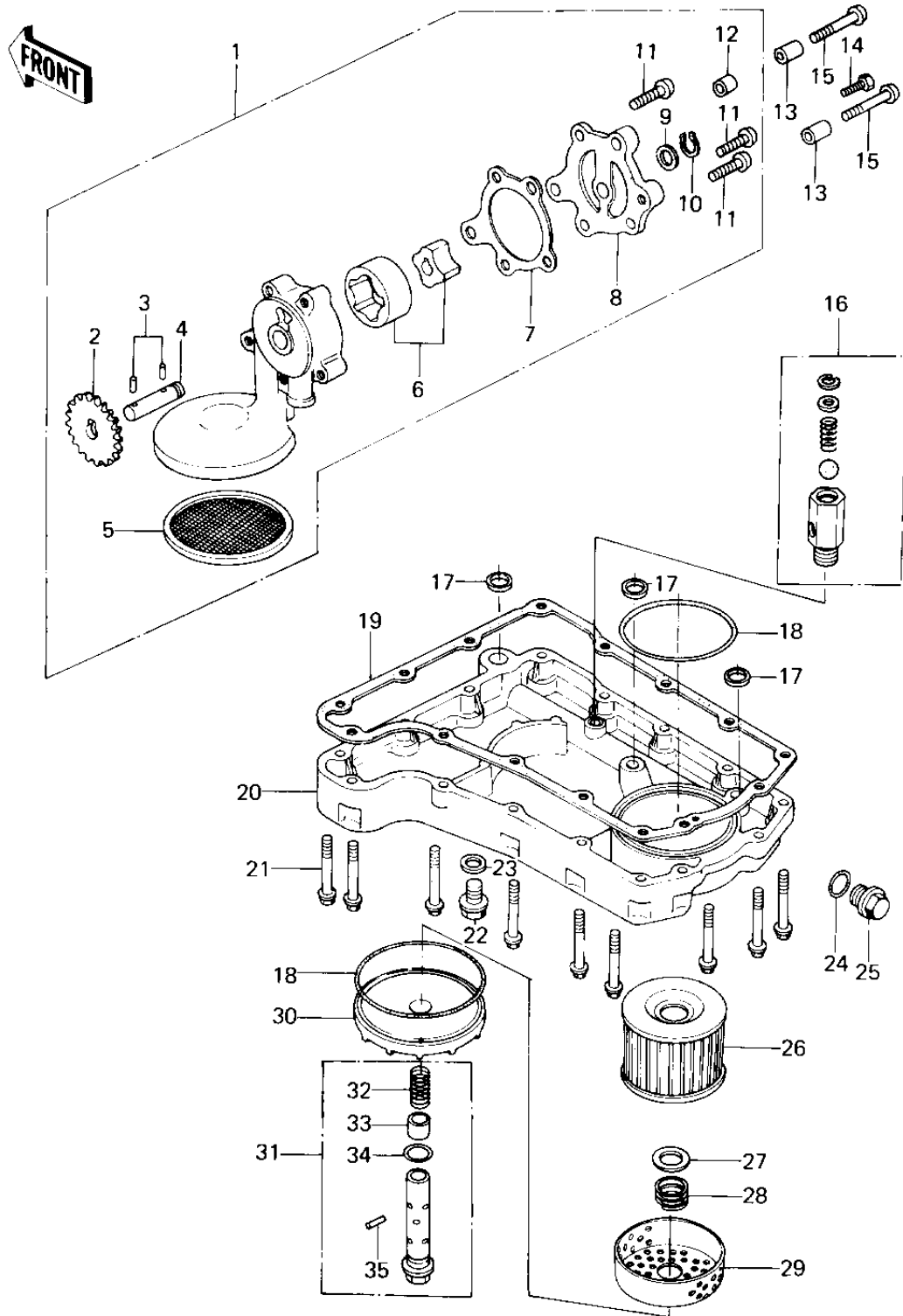

1979 Custom PARTS LIST

OIL PUMP/OIL FILTER/OIL PAN

ITEM NAME	PART NUMBER	QUANTITY
OIL PUMP ASSY (Ref # 1)	16082-064	1
GEAR,OIL PUMP,57T (Ref # 2)	16085-025	1
PIN,DOWEL (Ref # 3)	92042-041	2
SHAFT,OIL PUMP (Ref # 4)	16086-004	1
STRAINER,OIL PUMP (Ref # 5)	16111-004	1
ROTOR ASSY,OIL PUMP (Ref # 6)	16154-003	1
GASKET,OIL PUMP COVE (Ref # 7)	16145-004	1
COVER,OIL PUMP (Ref # 8)	16142-005	1
WASHER,PLAIN (Ref # 9)	92022-311	1
CIRCLIP,11MM (Ref # 10)	480J1100	1
SCREW PAN HEAD 6X22 (Ref # 11)	220B0622	3
PIN,DOWEL,8X10 (Ref # 12)	92043-1302	1
PIN,DOWEL,6.2X8X28 (Ref # 13)	92042-050	2
BOLT,HEX HEAD,6X45 (Ref # 14)	92001-165	1
SCREW,CONTRUNK HEAD (Ref # 15)	221B0650	2
RELEAF VALVE ASSY (Ref # 16)	16130-1001	1
RELEAF VALVE ASSY (Ref # 16)	16130-1001	1
"O" RING (Ref # 17)	92055-077	3
"O" RING,90MM (Ref # 18)	671B2590	2
GASKET,OIL PAN (Ref # 19)	11009-1983	1
PAN-OIL (Ref # 20)	49034-5011	1
BOLT,FLANGED,6X25 (Ref # 21)	130G0625	15
PLUG,OIL DRAIN,12X15 (Ref # 22)	92066-1174	1
GASKET,DRIN PLUG (Ref # 23)	92065-097	1
RING-O (Ref # 24)	92055-1146	1
PLUG (Ref # 25)	92066-066	1
FILTER,OIL (Ref # 26)	16099-003	1
SHIM-KICK SHAFT (Ref # 27)	92022-144	1
WASHER,20.5X30X1.0 (Ref # 27)	92022-1012	1

1979 Custom PARTS LIST

OIL PUMP/OIL FILTER/OIL PAN

ITEM NAME	PART NUMBER	QUANTITY
SPRING,OIL FILTER (Ref # 28)	92081-1018	1
SPRING,OIL FILTER (Ref # 28)	92081-1018	1
PLATE,OIL FILTER (Ref # 29)	13169-1110	1
COVER,OIL FILTER (Ref # 30)	16101-004	1
VALVE,OIL FILTER (Ref # 31)	16126-1108	1
UNAVAILABLE IN PRICE BOOK (Ref # 32)	92061-133	1
PISTON (Ref # 33)	92136-001	1
"O" RING,16MM (Ref # 34)	670B2016	1
SPRING PIN (Ref # 35)	92043-111	1