

1979 Custom PARTS DIAGRAM

HEADLIGHT

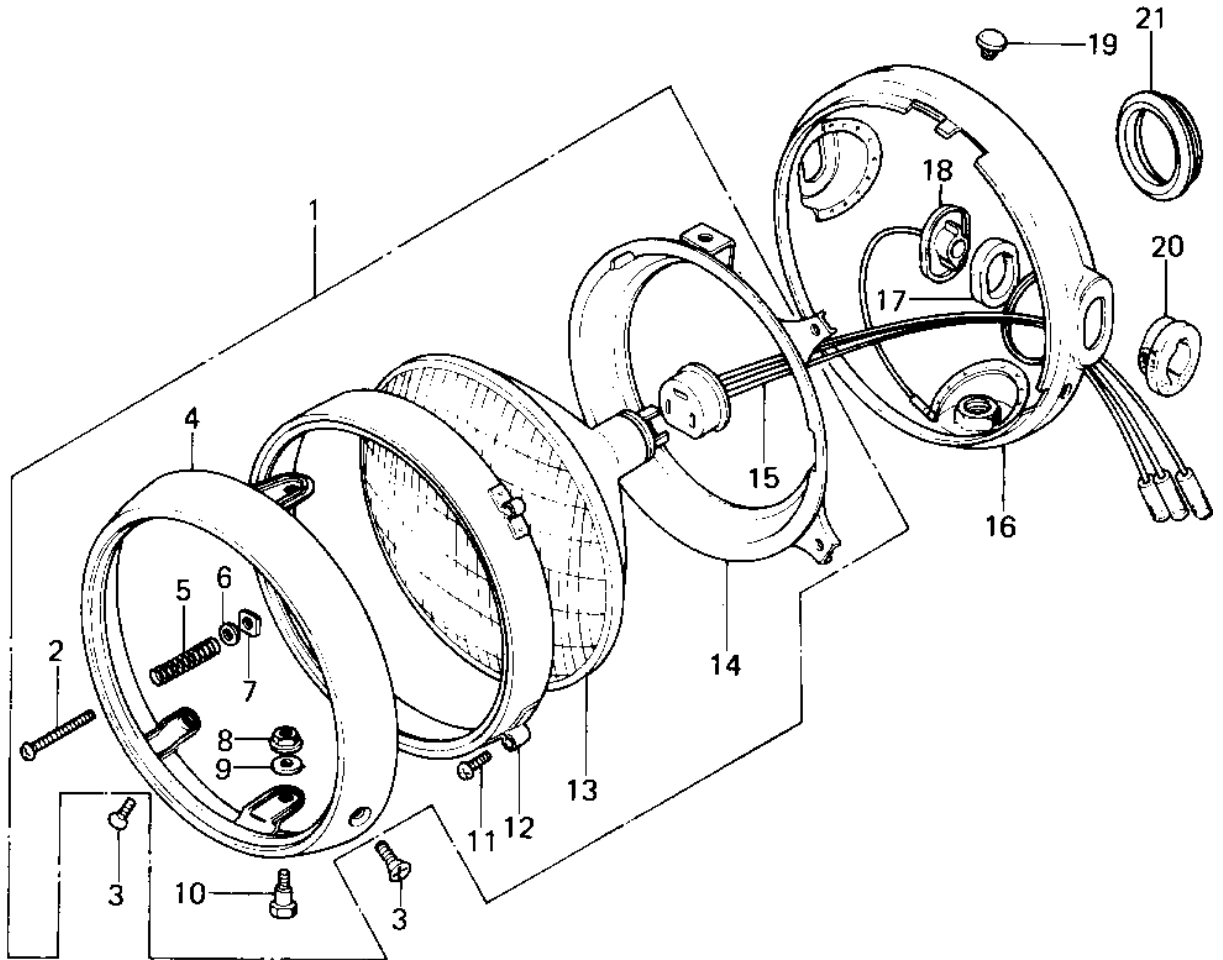

1979 Custom PARTS LIST

HEADLIGHT

ITEM NAME	PART NUMBER	QUANTITY
LAMP UNIT,HEAD (Ref # 1)	23003-017	1
SCREW FORCUS ADJUST (Ref # 2)	23019-021	1
SCREW,PAN HEAD,5X14 (Ref # 3)	23019-022	2
RIM,HEAD LAMP (Ref # 4)	23006-038	1
SPRING FOCUS ADJUST (Ref # 5)	23014-005	1
WASHER (Ref # 6)	23021-004	1
NUT,4MM (Ref # 7)	23020-018	2
NUT,HEAD LAMP RIM FI (Ref # 8)	23020-023	2
WASHER-PLAIN,5MM (Ref # 9)	23021-012	2
SCREW-PAN HEAD,5X12 (Ref # 10)	23019-023	2
SCREW PAN HEAD 3X12 (Ref # 11)	220B0312	2
RING,HEAD LAMP MOUNT (Ref # 12)	23072-001	1
SEALD BEAM UNIT (Ref # 13)	23007-041	1
RING,HEAD LAMP MOUNT (Ref # 14)	23074-001	1
SOCKET ASSY,HEAD LAM (Ref # 15)	23008-037	1
BODY-COMP-HEAD LAMP (Ref # 16)	23005-1015-21	1
BODY-COMP-HEAD LAMP (Ref # 16)	23005-1015-21	1
DAMPER RUBBER (Ref # 17)	23066-016	2
COLLAR (Ref # 18)	23076-005	2
PLUG REAR FENDER RUB (Ref # 19)	92074-006	1
DAMPER RUBBER (Ref # 20)	23066-015	2
GROMMET (Ref # 21)	92071-1008	1