

1979 SR PARTS DIAGRAM

CYLINDER/PISTONS/CRANKSHAFT

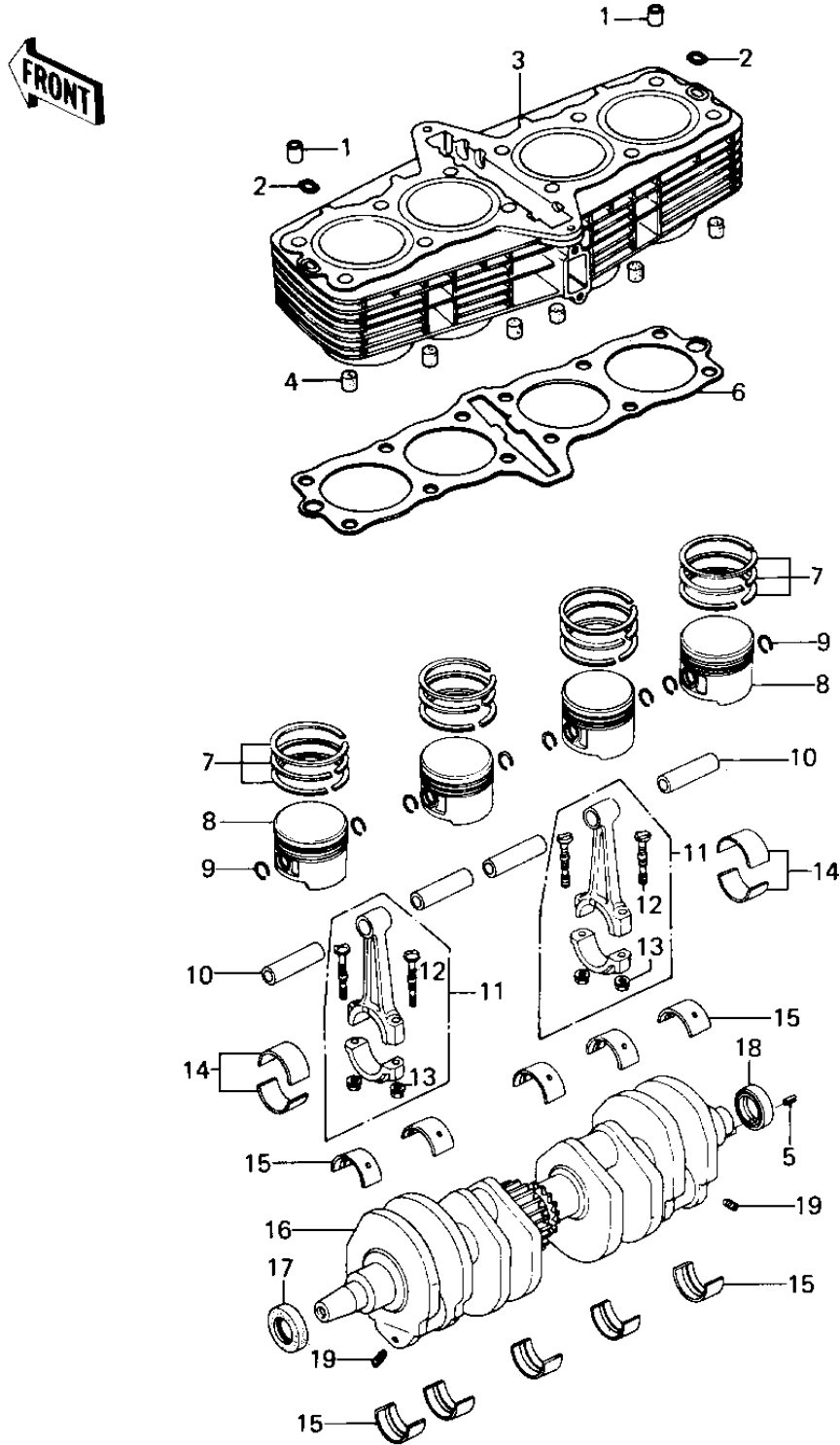

1979 SR PARTS LIST

CYLINDER/PISTONS/CRANKSHAFT

ITEM NAME	PART NUMBER	QUANTITY
PIN,11X14X12.3 (Ref # 1)	92043-1266	2
RING-O (Ref # 2)	92055-1147	2
CYLINDER (Ref # 3)	11005-1039	1
PLUG,DAMPER (Ref # 4)	92066-1016	6
PIN-SPRING,4X8 (Ref # 5)	555A0408	1
GASKET (Ref # 6)	11060-1362	1
RING SET,PISTON,STD (Ref # 7)	13008-059	4
RING SET,0.020",O.S. (Ref # 7)	13025-061	(4
RING SET,0.040",O.S. (Ref # 7)	13024-060	(4
PISTON,STD (Ref # 8)	13001-1002	4
PISTON,STD (Ref # 8)	13001-1002	4
PISTON,0.020",O.S. (Ref # 8)	13029-077	(4
PISTON,0.040",O.S. (Ref # 8)	13027-069	(4
CIRCLIP PISTON PIN (Ref # 9)	92036-005	8
PIN-PISTON (Ref # 10)	13002-032	4
CONNECTING ROD ASSY (Ref # 11)	13251-1003-HH	4
CONNECTING ROD ASSY,J (Ref # 11)	13251-1007-JJ	4
CONNECTING ROD ASSY,J (Ref # 11)	13251-1007-JJ	4
BOLT,CONNECTING ROD (Ref # 12)	92001-175	8
BOLT,CONNECTING ROD (Ref # 12)	92001-1793	8
NUT,CONNECTING ROD (Ref # 13)	92016-060	8
METAL,CONNECT ROD BRG (Ref # 14)	13034-050	8
METAL,CONNECT ROD BRG (Ref # 14)	13034-051	8
METAL,CONNECT ROD BRG (Ref # 14)	13034-052	8
BUSHING,CRANKSHAFT (Ref # 15)	92028-1102	10
CRANKSHAFT ASSY (Ref # 16)	13037-069	1
OIL SEAL,HSCY22397 (Ref # 17)	92050-080	1
OIL SEAL,HSCY25397 (Ref # 18)	92050-081	1
SCREW,SLOTTED,6X8 (Ref # 19)	291H0608	2