

# 1978 SR PARTS DIAGRAM

## SECONDARY SHAFT/STARTER CLUTCH

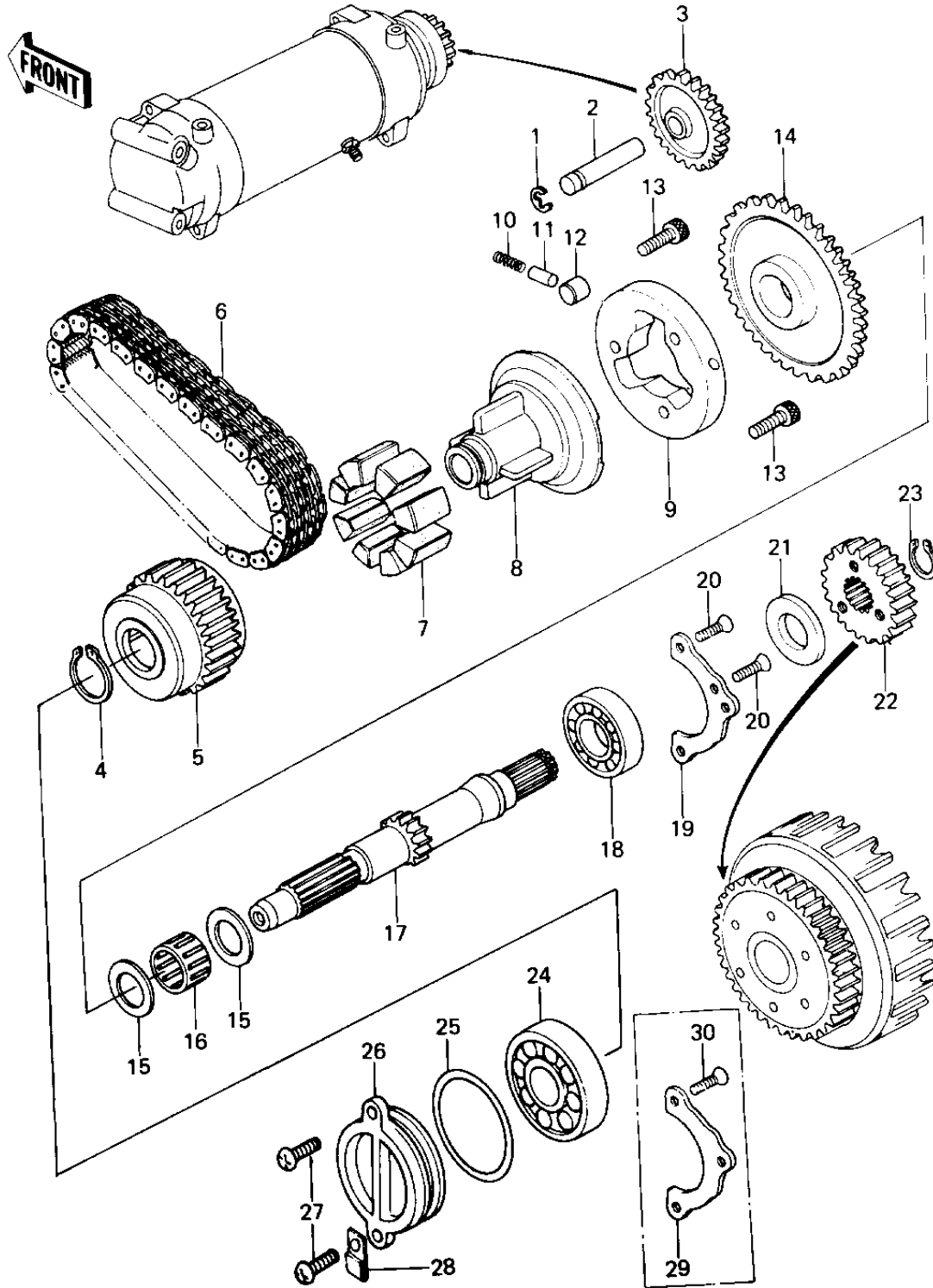

# 1978 SR PARTS LIST

## SECONDARY SHAFT/STARTER CLUTCH

ITEM NAME	PART NUMBER	QUANTITY
CIRCLIP 12MM (Ref # 1)	482K0200	2
SHAFT,IDLE GEAR (Ref # 2)	21143-003	2
GEAR,IDLE,29T (Ref # 3)	21167-004	2
CIRCLIP 28MM (Ref # 4)	480J2800	2
COUPLING,OUTER (Ref # 5)	13252-001	2
CHAIN,PRIMARY 52L (Ref # 6)	13122-007	2
DAMPER RUBBER (Ref # 7)	13098-029	2
COUPLING,INNER (Ref # 8)	13253-001	2
CLUTCH-ASSY-ONEWAY (Ref # 9)	13193-1012	2
SPRING (Ref # 10)	92081-110	2
PIN (Ref # 11)	92043-087	2
ROLLER (Ref # 12)	92122-004	2
BOLT,SOCKET,8X12 (Ref # 13)	120P0812	2
SPROCKET,STARTER,58T (Ref # 14)	12046-1032	2
SPACER,STARTER CLUTCH (Ref # 15)	92026-117	2
BRG,NEEDLE,K253017 (Ref # 16)	92046-056	2
SHAFT,SECONDARY (Ref # 17)	13127-054	2
BEARING BALL #6305 (Ref # 18)	601B6305	2
PLATE,POSITIONING (Ref # 19)	14014-1007	2
SCREW CNTSNK HD 6X20 (Ref # 20)	221B0620	2
COLLAR,T=5MM (Ref # 21)	92027-263	2
GEAR,2ND SHAFT,29T (Ref # 22)	13121-037	2
CIRCLIP,22MM (Ref # 23)	480J2200	2
BEARING BALL #6304 (Ref # 24)	601B6304	2
"O" RING,46MM (Ref # 25)	670B3046	2
PLUG,SECONDARY SHAFT (Ref # 26)	92066-1019	2
SCREW PAN HEAD 6X20 (Ref # 27)	220B0620	2
CLAMP,WIRING HARNESS (Ref # 28)	21126-008	2
PLATE,POSITIONING (Ref # 29)	14014-1007	2