

1979 SR PARTS DIAGRAM

SWING ARM/SHOCK ABSORBERS

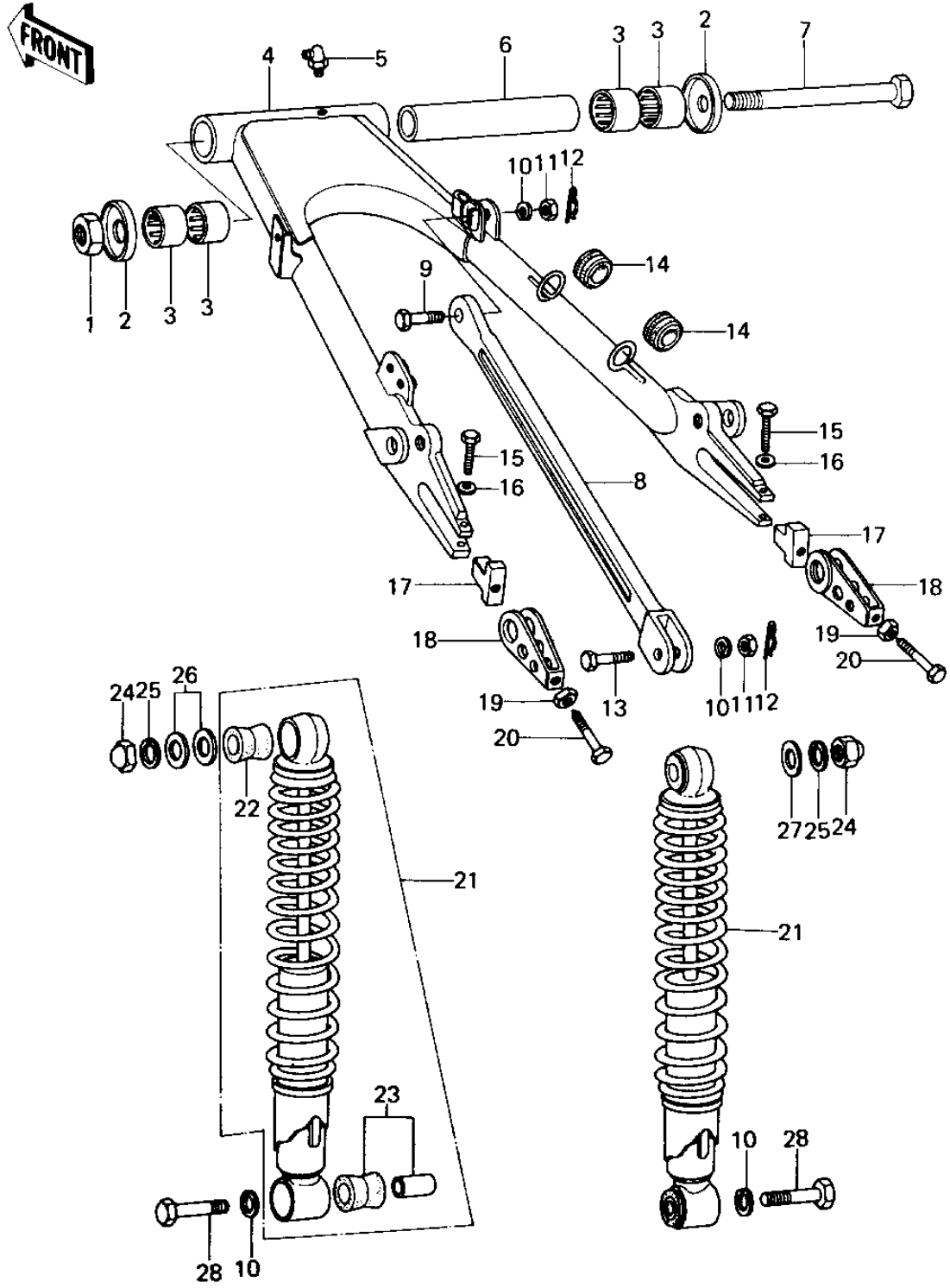

1979 SR PARTS LIST

SWING ARM/SHOCK ABSORBERS

ITEM NAME	PART NUMBER	QUANTITY
NUT-SELF LOCKING (Ref # 1)	92019-012	1
CAP,SWING ARM (Ref # 2)	33035-009	2
BEARING-NEEDLE,HK2216 (Ref # 3)	92046-1115	4
ARM-COMP-SWING (Ref # 4)	33001-1081	1
GREASE NIPPLE (Ref # 5)	92005-002	1
SLEEVE,SWING ARM (Ref # 6)	42036-1012	1
SHAFT,SWING ARM (Ref # 7)	33032-050	1
TORQUE LINK,REAR HUB (Ref # 8)	43007-049	1
BOLT,HEX HEAD,10X39 (Ref # 9)	92003-218	1
WASHER SPRING 10MM (Ref # 10)	461F1000	4
NUT,10MM (Ref # 11)	314B1000	2
PIN,SNAP (Ref # 12)	554A0800	2
BOLT,10X47 (Ref # 13)	92001-1145	1
DAMPER RUBBER (Ref # 14)	43064-007	2
BOLT,FLANGED,8X35 (Ref # 15*)	92001-1577	2
WASHER SPRING 8MM (Ref # 16*)	461F0800	2
STOPPER,CHAIN ADJUST (Ref # 17*)	33044-002	2
ADJUSTER,CHAIN (Ref # 18)	33040-056	2
NUT 8MM (Ref # 19)	312B0800	2
BOLT,8X50 (Ref # 20)	92001-1399	2
SHOCK ABSBR RR (Ref # 21)	45014-1009	2
BUSHING,SHOCK ABSORB (Ref # 22)	45017-020	2
BUSHING,SHOCK ABSORBE (Ref # 23)	45017-019	2
NUT 12MM (Ref # 24)	92020-014	2
WASHER SPRING 12MM (Ref # 25)	461F1200	2
WASHER PLAIN 12MM (Ref # 26)	410B1200	2
WASHER,PLAIN,12 X 22 (Ref # 27)	92022-1057	1
BOLT HEX HEAD 10X35 (Ref # 28)	113N1035	2