

1974 Mach IV PARTS DIAGRAM

CLUTCH

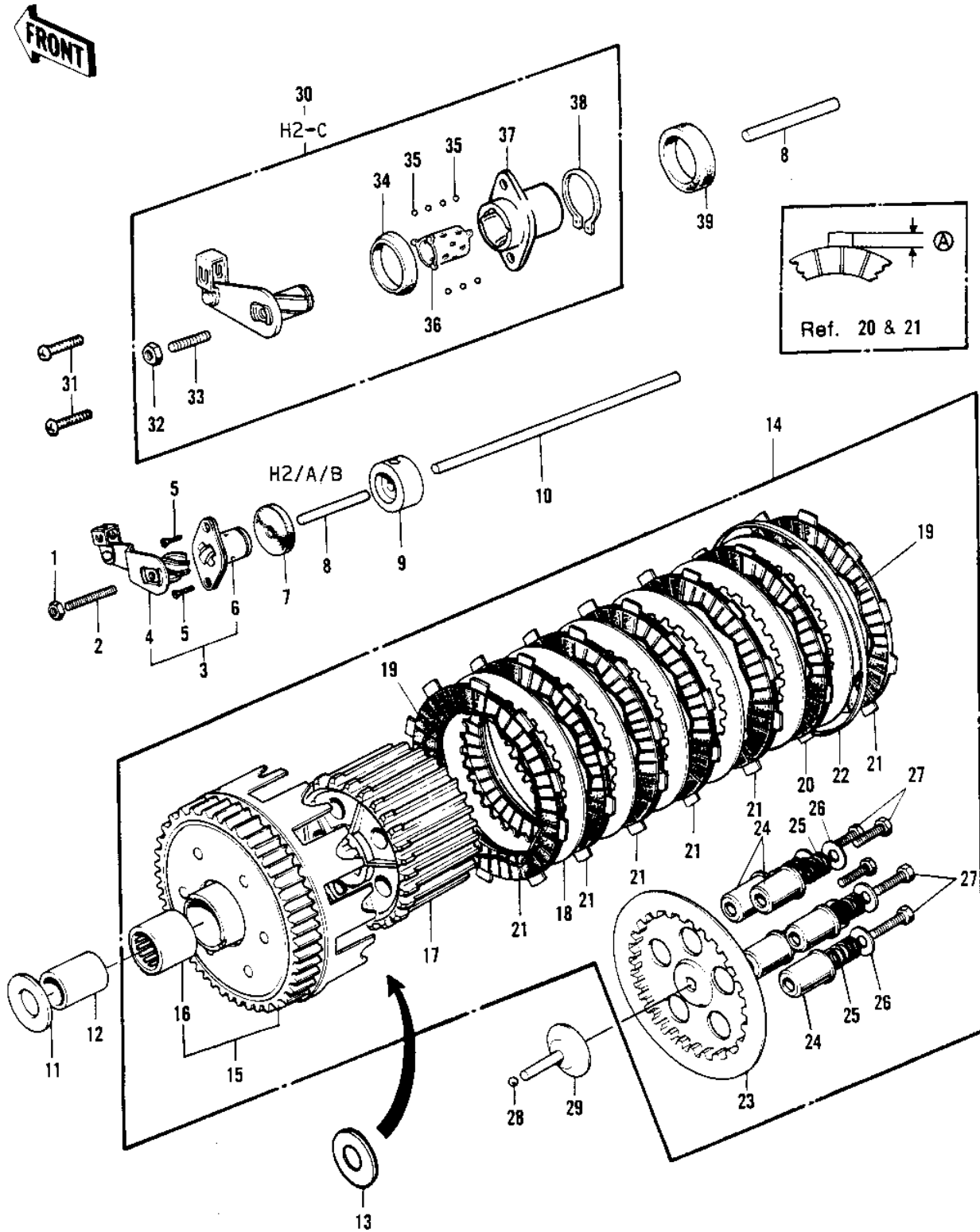

1974 Mach IV PARTS LIST

CLUTCH

ITEM NAME	PART NUMBER	QUANTITY
NUT 6MM (Ref # 1)	311B0600	
SCREW SLOTTED (Ref # 2)	291Z0625	
RELEASE ASSY,CLUTCH (Ref # 3)	13231-010	
INNER,CLUTCH RELEASE (Ref # 4)	13102-017	
SCREW CNTSNK HD 6X16 (Ref # 5)	221B0616	
OUTER,CLUTCH RELEASE (Ref # 6)	13118-008	
OIL SEAL SC7317 (Ref # 7)	92050-025	
ROD CLUTCH PUSH SHORT (Ref # 8)	13116-010	
BUSH CLUTCH PUSH ROD (Ref # 9)	92028-070	
ROD CLUTCH PUSH LONG (Ref # 10)	13116-009	
WASHER-PLAIN (Ref # 11)	92022-186	
BUSH CLUTCH (Ref # 12)	92028-045	
WASHER TH 25.5X47X2.5 (Ref # 13)	92026-022	
CLUTCH-ASSY (Ref # 14)	13081-073	
CLUTCH-ASSY (Ref # 14)	13081-073	
HOUSING-CLUTCH (Ref # 15)	13095-029	
BEARING NEEDLE (Ref # 16)	92046-004	
CLUTCH-ASSY (Ref # 17)	13081-073	
PLATE-CLUTCH (Ref # 18)	13089-1073	
RING-CLUTCH STEEL (Ref # 19)	13229-003	
PLATE-CLUTCH FRICTION (Ref # 20)	13088-028	
PLATE,CLUTCH FRICTION (Ref # 20)	13088-1063	
PLATE,CLUTCH FRICTION (Ref # 20)	13088-1063	
PLATE-CLUTCH FRICTION (Ref # 21)	13088-021	
PLATE CLUTCH FRICTION (Ref # 21)	13088-015	
PLATE,CLUTCH FRICTION (Ref # 21)	13088-1008	
HOLDER-CLUTCH HOUSING (Ref # 22)	13238-001	
PLATE-CLUTCH SPRING (Ref # 23)	13187-005	
GUIDE CLUTCH SPRING (Ref # 24)	13092-005	

1974 Mach IV PARTS LIST

CLUTCH

ITEM NAME	PART NUMBER	QUANTITY
SPRING-CLUTCH (Ref # 25)	92081-100	
HOLDER CL SPG6.5X20X2 (Ref # 26)	13091-009	
BOLT-UPSET (Ref # 27)	112G0618	
BALL STEEL 5/16" (Ref # 28)	600A1000	
PUSHER-CLTCH SPRG PLT (Ref # 29)	13116-011	
RELEASE ASSY,CLUTCH (Ref # 30)	13231-1001	
SCREW PAN HEAD 6X16 (Ref # 31)	220B0616	
NUT 6MM (Ref # 32)	311B0600	
SCREW SLOTTED (Ref # 33)	291Z0625	
OIL SEAL (Ref # 34)	92056-007	
BALL,STEEL,1/8" (Ref # 35)	600A0400	
RETAINER (Ref # 36)	13197-006	
OUTER,CLUTCH RELEASE (Ref # 37)	13118-015	
CIRCLIP 15MM (Ref # 38)	480J1500	
OIL SEAL (Ref # 39)	92050-070	