

1975 Mach IV PARTS DIAGRAM

GEAR CHANGE MECHANISM

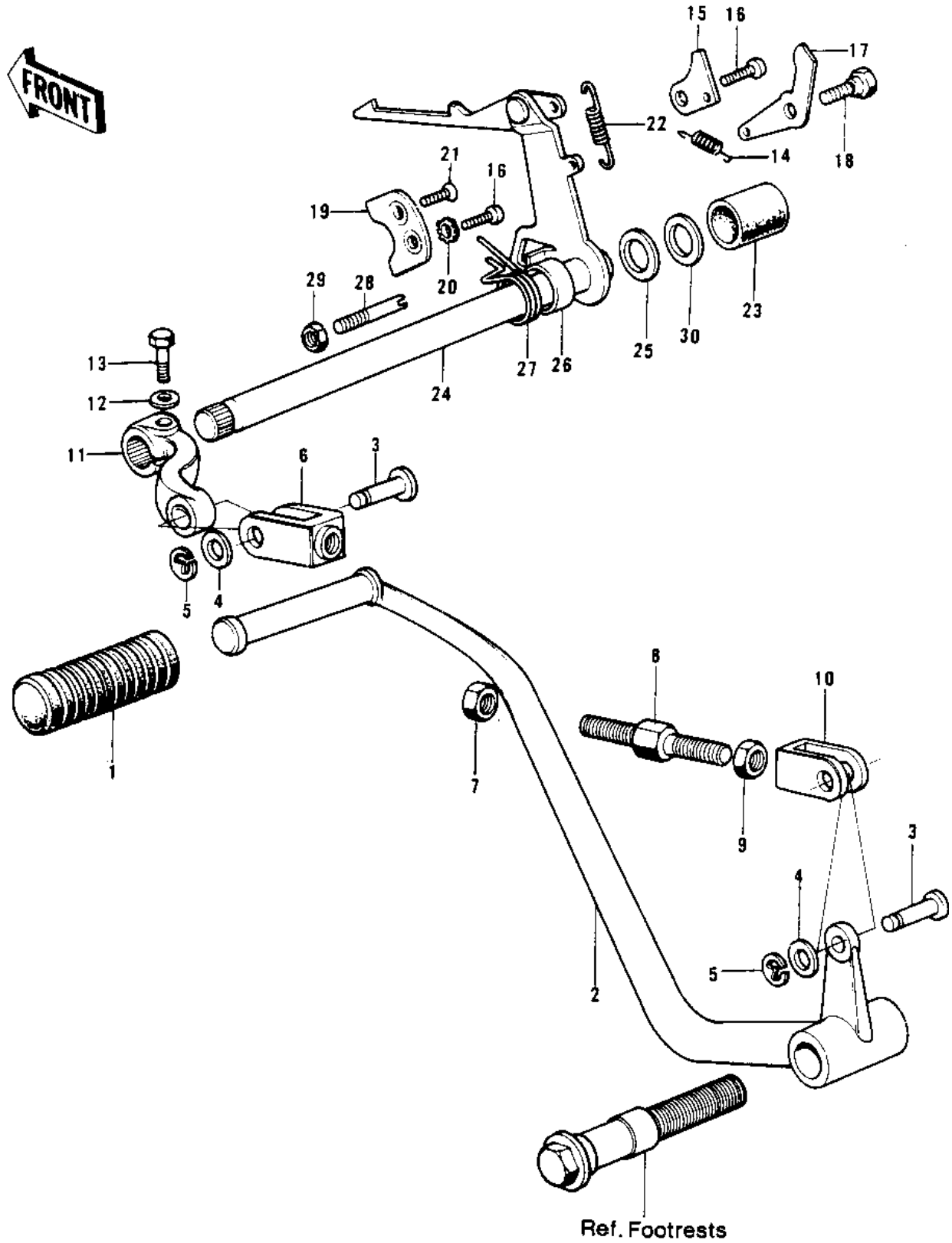

1975 Mach IV PARTS LIST

GEAR CHANGE MECHANISM

ITEM NAME	PART NUMBER	QUANTITY
RUBBER CHANGE PEDAL (Ref # 1)	13157-004	
PEDAL GEAR CHANGE (Ref # 2)	13156-039	
PIN (Ref # 3)	92043-069	
WASHER PLAIN 8MM (Ref # 4)	410B0800	
WASHER,PLAIN (Ref # 4)	92022-1028	
CIRCLIP 5MM (Ref # 5)	482K5000	
CONNECTOR,B (Ref # 6)	13159-008	
NUT,8MM (Ref # 7)	92017-010	
BOLT-HEX HEAD,8MM (Ref # 8)	92003-072	
NUT,8MM (Ref # 9)	318N0800	
CONNECTOR,A (Ref # 10)	13159-007	
LEVER-GEAR CHANGE (Ref # 11)	13158-011	
WASHER SPRING 8MM (Ref # 12)	461F0800	
BOLT,8X20 (Ref # 13)	115G0820	
BOLT-SMALL-UPSET,8X22 (Ref # 13)	115B0822	
SPRING,CHNG DRUM LEVR (Ref # 14)	92081-1045	
PLATE CHANGE DRUM LEV (Ref # 15)	13170-004	
SCREW PAN HEAD 6X16 (Ref # 16)	220B0616	
LEVER GEAR CHNG DRUM (Ref # 17)	13168-012	
BOLT,CHANGE DRUM LEVE (Ref # 18)	92150-1450	
PLATE CHNG DRUM PSTON (Ref # 19)	13169-005	
WASHER LOCK 6MM (Ref # 20)	464H0600	
SCREW CNTSNK HD 6X16 (Ref # 21)	212B0616	
SPRING,CHANGE LEVER (Ref # 22)	92144-1720	
RUBBER CAP (Ref # 23)	13080-004	
LEVER ASSY GEAR CHNG (Ref # 24)	13161-035	
LEVER ASSY GEAR CHNG (Ref # 24)	13161-035	
SPACER (Ref # 25)	92026-068	
COLLAR (Ref # 26)	92027-121	

1975 Mach IV PARTS LIST

GEAR CHANGE MECHANISM

ITEM NAME	PART NUMBER	QUANTITY
SPRING,TENTION (Ref # 27)	92081-1129	
BOLT,RETURN SPRING (Ref # 28)	92001-1401	
NUT 8MM (Ref # 29)	312B0800	
SHIM-KICK SHAFT,0.5T (Ref # 30)	92022-150	