

1975 Mach IV PARTS DIAGRAM

OIL PUMP (H2/A)

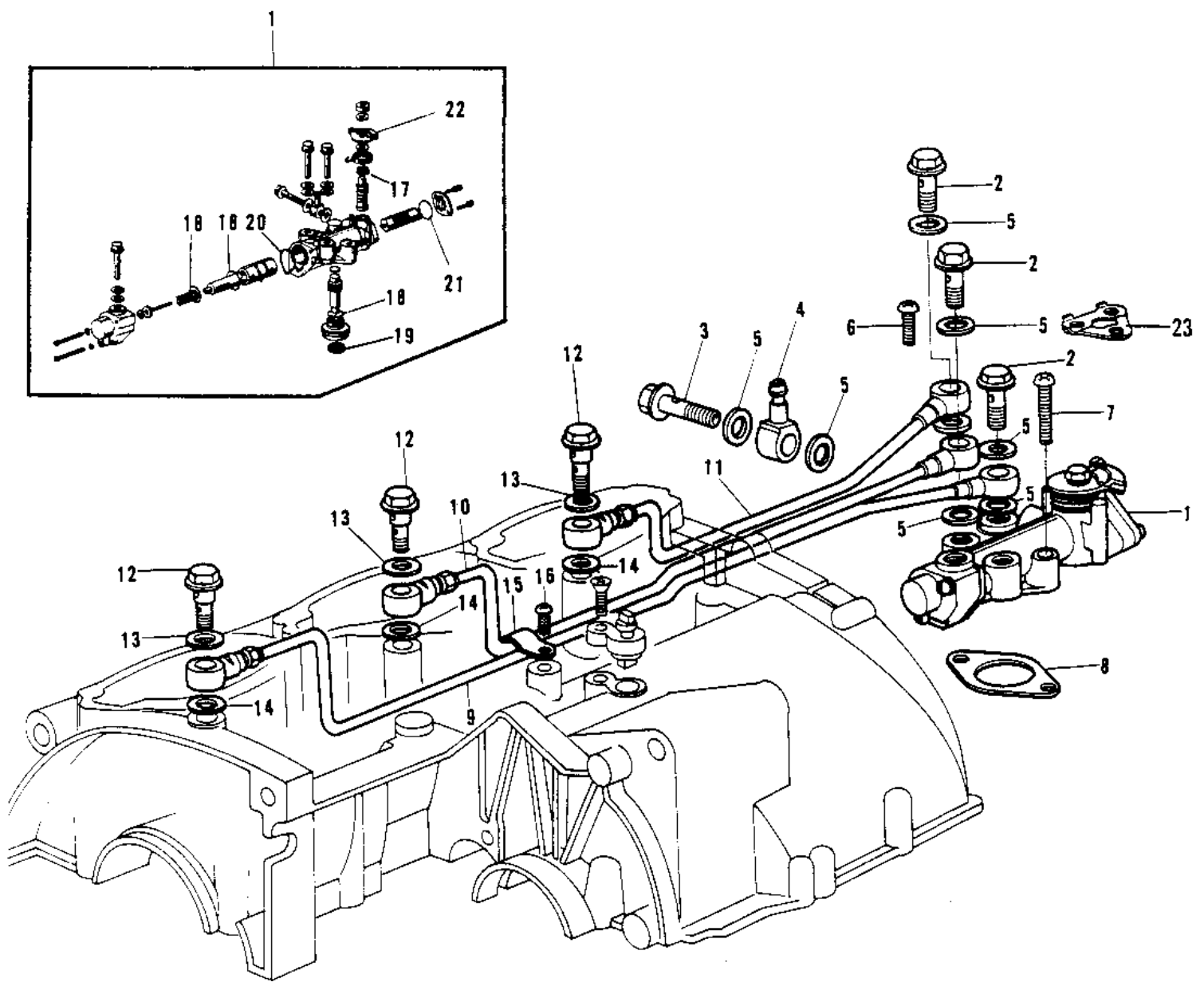

1975 Mach IV PARTS LIST

OIL PUMP (H2/A)

ITEM NAME	PART NUMBER	QUANTITY
OIL PUMP ASSY (Ref # 1)	16082-042	
BOLT BANJO (Ref # 2)	92060-008	
BOLT BANJO (Ref # 3)	92060-009	
CONNECTOR BANJO (Ref # 4)	92061-015	
WASHER OIL PUMP BANJO (Ref # 5)	92022-077	
SCREW-PAN-CROS (Ref # 6)	220B0514	
SCREW PAN CROSS,5X28 (Ref # 7)	220B0528	
GASKET,OIL PUMP (Ref # 8)	11060-1160	
PIPE-OIL,L.H (Ref # 9)	16134-016	
PIPE-OIL,CENTER (Ref # 10)	16134-017	
PIPE-OIL,R.H (Ref # 11)	16134-018	
BOLT-BANJO,CR (Ref # 12)	92060-010-79	
GASKET CHECK VALVE (Ref # 13)	92065-058	
GASKET CHECK VALVE (Ref # 14)	92065-023	
HOLDER OIL PIPE (Ref # 15)	16068-004	
SCREW PAN HEAD 6X10 (Ref # 16)	220B0610	
SEAL-OIL,CAMSHAFT,"X" (Ref # 17)	92049-1294	
"O" RING,OIL PUMP SHT (Ref # 18)	16090-002	
OIL SEAL OIL PUMP SHT (Ref # 19)	16091-001	
"O" RING,UPPER CAP (Ref # 20)	16088-002	
"O" RING,LOWER CAP (Ref # 21)	16090-003	
LEVER-OIL PUMP CABLE (Ref # 22)	16096-006	
WASHER,OIL PUMP LOCK (Ref # 23)	92024-058	