

1973 Mach IV PARTS DIAGRAM

HANDLEBAR (H2-B/C)

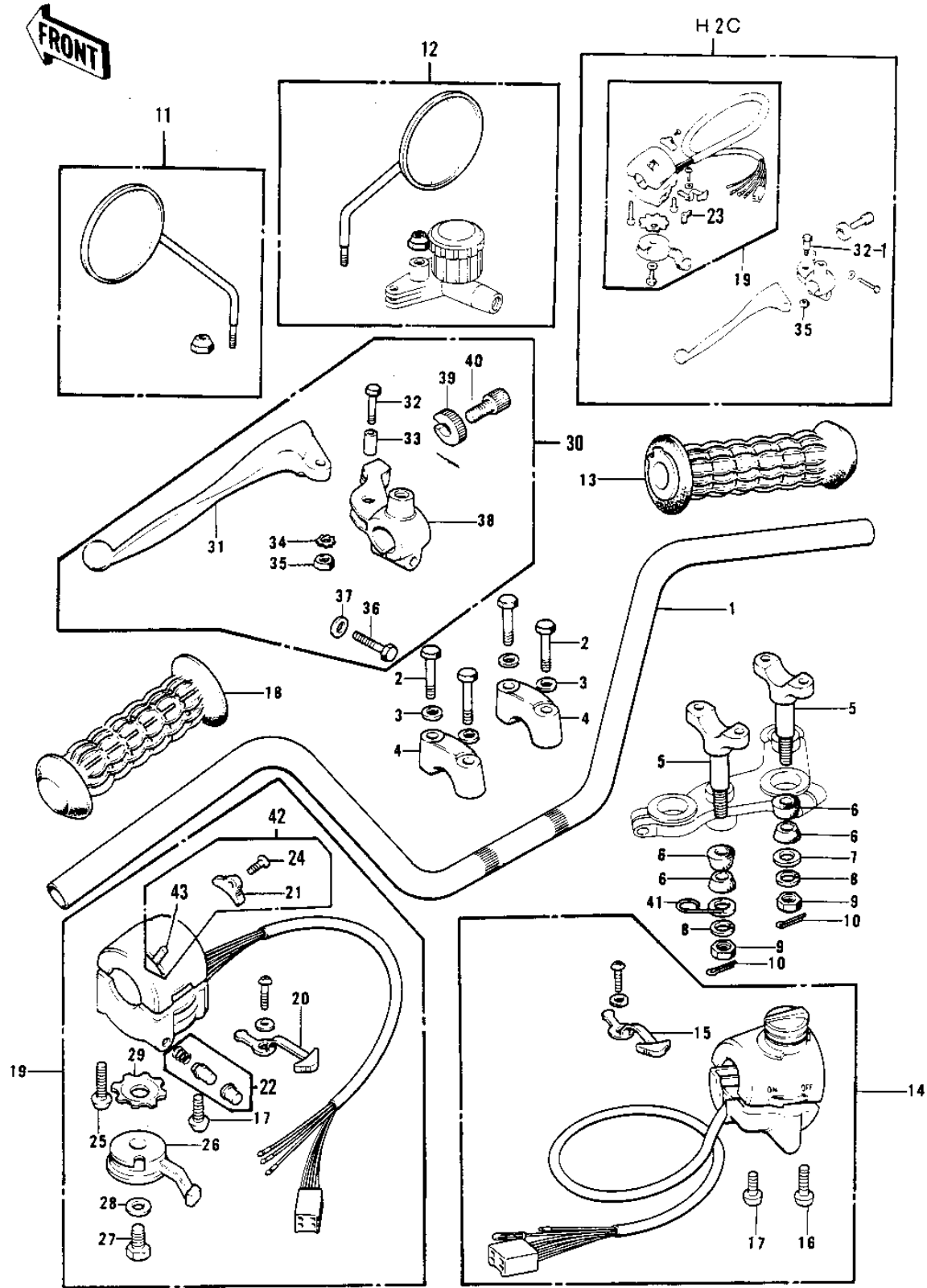

1973 Mach IV PARTS LIST

HANDLEBAR (H2-B/C)

ITEM NAME	PART NUMBER	QUANTITY
HANDLEBAR (Ref # 1)	46003-032	
BOLT 8X38 (Ref # 2)	92001-1405	
BOLT 8X38 (Ref # 2)	92001-1405	
WASHER SPRING 8MM (Ref # 3)	461F0800	
HOLDER-HANDLEBAR (Ref # 4)	46012-008	
HOLDER-HANDLEBAR LOW (Ref # 5)	46012-010	
DAMPER RUBBER,HANDLE (Ref # 6)	92075-275	
WASHER-HANDLEBAR FIT (Ref # 7)	92022-196	
WASHER SPRING 10MM (Ref # 8)	461F1000	
NUT,10MM (Ref # 9)	314B1000	
PIN,SNAP (Ref # 10)	554A0800	
PIN,SNAP (Ref # 10)	554A0800	
REAR VIEW MIRROR,L.H (Ref # 11)	56003-009	
REAR VIEW MIRROR,R.H (Ref # 12)	56002-020	
GRIP ASSY-THROTTLE (Ref # 13)	46019-023	
CASE ASSY,R.H (Ref # 14)	46132-003	
CASE ASSY,R.H (Ref # 14)	46132-019	
KNOB,LIGHING SWITCH (Ref # 15)	46043-006	
SCREW-PAN-CROS (Ref # 16)	220B0535	
SCREW PAN HEAD 5X22 (Ref # 17)	220B0522	
RUBBER-L.H GRIP (Ref # 18)	46075-017	
CASE ASSY,L.H (Ref # 19)	46091-014	
CASE ASSY,L.H (Ref # 19)	46091-047	
KNOB,LIGHTING SW L.H (Ref # 20)	46043-005	
KNOB,LIGHTING SW L.H (Ref # 21)	46044-013	
SWITCH ASSY,HORN BUTN (Ref # 22)	27010-1009	
BUTTON,HORN PUSH (Ref # 23)	27010-1001	
SCREW PAN HEAD 3X5 (Ref # 24)	220B0305A	
SCREW PAN HEAD 5X30 (Ref # 25)	220B0530	

1973 Mach IV PARTS LIST

HANDLEBAR (H2-B/C)

ITEM NAME	PART NUMBER	QUANTITY
LEVER,STARTER (Ref # 26)	46096-009	
BOLT HEX HEAD 6X8 (Ref # 27)	110B0608	
WASHER PLAIN 6MM (Ref # 28)	410B0600	
WASHER LOCK (Ref # 29)	92095-012	
LEVER ASSY,CLUTCH (Ref # 30)	46076-036	
LEVER-CLUTCH (Ref # 31)	46092-015	
BOLT HEX HEAD 5X20 (Ref # 32)	92007-020	
BOLT,HEX HEAD,5X22 (Ref # 32-1)	92007-046	
COLLAR LEVER (Ref # 33)	46059-011	
WASHER LOCK 5MM (Ref # 34)	464H0500	
NUT 5MM (Ref # 35)	312B0500	
NUT-LOCK,5MM (Ref # 35)	92019-014	
BOLT HEX HEAD 6X25 (Ref # 36)	110N0625	
WASHER PLAIN 6MM (Ref # 37)	410B0600	
HOLDER-CLUTCH LEV,BLK (Ref # 38)	46094-011-21	
NUT-LOCK (Ref # 39)	46056-005	
SCREW ADJUST (Ref # 40)	46055-006	
CLAMP,CABLE (Ref # 41)	92037-148	
L.H GRIP SWITCH KIT (Ref # 42)	99990-530	
SWITCH ASSY,L.H (Ref # 43)	46089-016	
SWITCH,L.H (Ref # 43)	46089-014	