

# 1979 KZ750-B4 PARTS DIAGRAM

CAMSHAFTS/CHAIN/TENSIONER

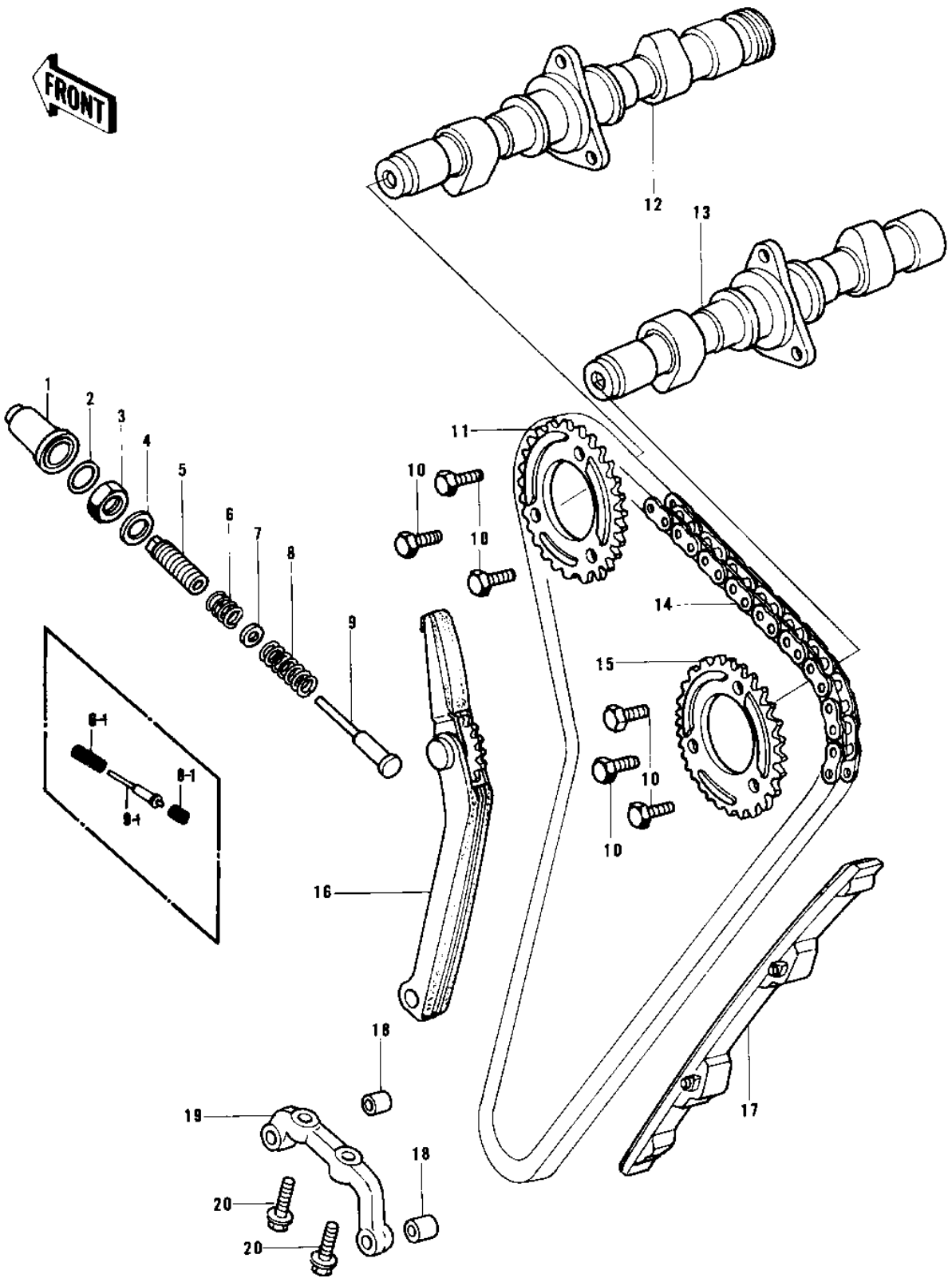

1  
-

10

# 1979 KZ750-B4 PARTS LIST

## CAMSHAFTS/CHAIN/TENSIONER

ITEM NAME	PART NUMBER	QUANTITY
CAP,CHN TENSIONER (Ref # 1)	12064-003	
"O" RING (Ref # 2)	92055-095	
NUT 18MM (Ref # 3)	92015-019	
WASHER,PLAIN (Ref # 4)	92022-320	
BOLT (Ref # 5)	92003-188	
BOLT,PUSH ROD (Ref # 5)	92001-1009	
SPRING (Ref # 6)	92081-144	
SPRING (Ref # 6-1)	92081-1008	
WASHER,PLAIN (Ref # 7)	92022-312	
SPRING,CHN TENSIONER (Ref # 8)	92081-143	
SPRING,PUSH ROD (Ref # 8-1)	92081-1007	
ROD,PUSH (Ref # 9)	12054-004	
ROD,PUSH (Ref # 9-1)	13116-1001	
BOLT,SPROCKET FITTING (Ref # 10)	92003-208	
BOLT,SPROCKET FITTING (Ref # 10)	92003-208	
SPROCKET,CAM SFT,EXH (Ref # 11)	12046-007	
CAMSHAFT,EXHAUST (Ref # 12)	12044-020	
CAM SHAFT,INLET (Ref # 13)	12044-010	
CHAIN,CAM (Ref # 14)	21070-011	
SPROCKET,CAM SFT,IN (Ref # 15)	12046-006	
TENSIONER ASSY,CAM (Ref # 16)	12048-005	
SLIPPER,CAM CHAIN (Ref # 17)	12053-015	
PIN,DOWEL,10X32 (Ref # 18)	551A1032	
HOLDER (Ref # 19)	14018-006	
BOLT (Ref # 20)	92003-202	