

1979 KZ750-B4 PARTS DIAGRAM

KICKSTARTER MECHANISM

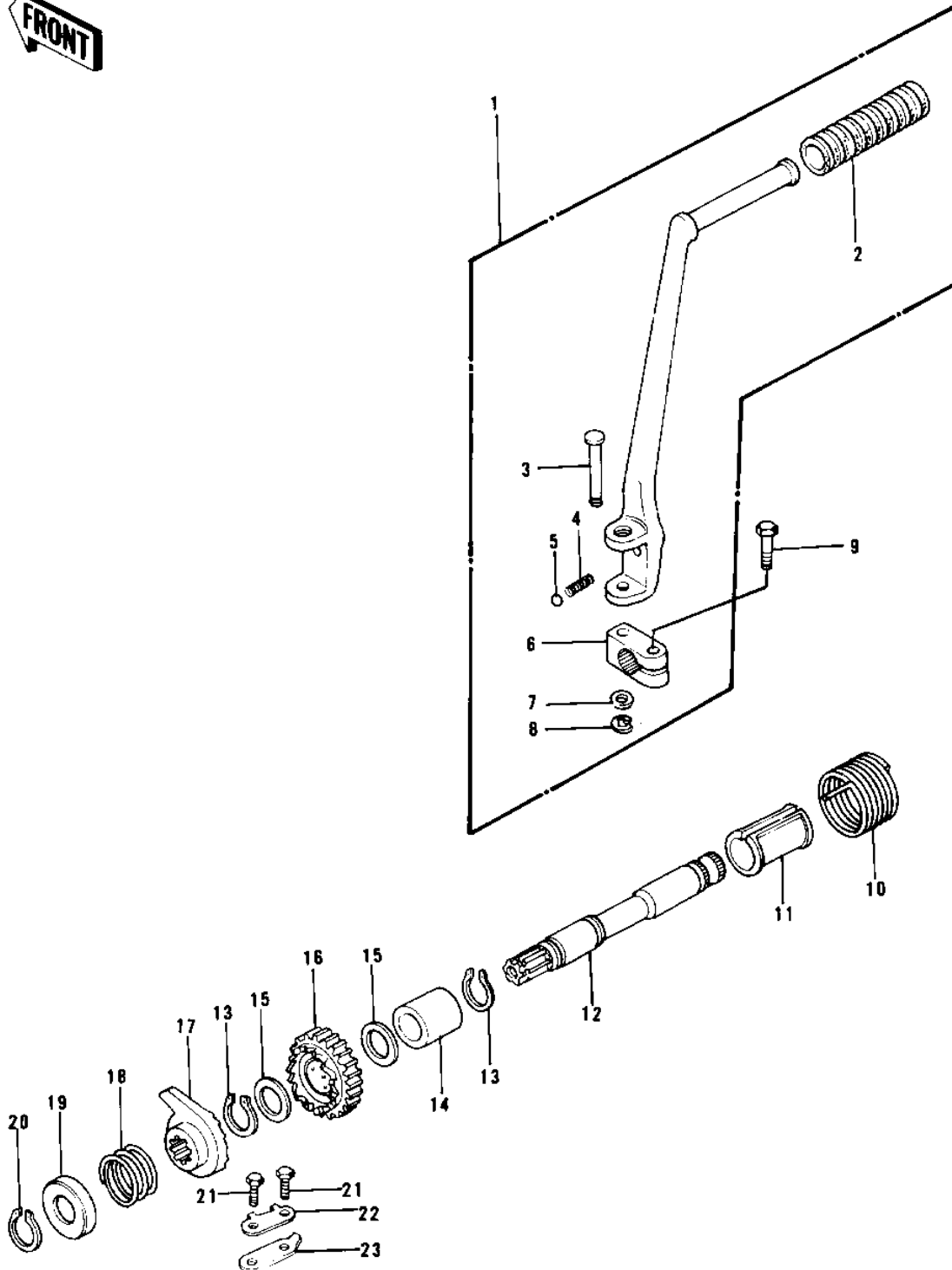

10:

1979 KZ750-B4 PARTS LIST

KICKSTARTER MECHANISM

ITEM NAME	PART NUMBER	QUANTITY
PEDAL ASSY,KICK (Ref # 1)	13058-061	
RUBBER KICK PEDAL (Ref # 2)	13063-004	
PIN-KICK PEDAL (Ref # 3)	92043-081	
SPRING KICK PEDAL (Ref # 4)	92081-020	
BALL STEEL 1/4' (Ref # 5)	600A0800	
BOSS-KICK PEDAL (Ref # 6)	13061-010	
WASHER PLAIN 8MM (Ref # 7)	410B0800	
CIRCLIP 5MM (Ref # 8)	482K5000	
BOLT-KICK PEDAL (Ref # 9)	92001-110	
SPRING,KICKSTARTER (Ref # 10)	92082-004	
GUID,KICK SHAFT (Ref # 11)	13070-005	
SHAFT,KICKSTARTER (Ref # 12)	13066-029	
SHAFT,KICKSTARTER (Ref # 12)	13066-1004	
CIRCLIP,25MM (Ref # 13)	92033-025	
COLLAR,KICKSHAFT (Ref # 14)	92028-126	
WASHER,PLAIN,22MM (Ref # 15)	92022-207	
GEAR,KICK (Ref # 16)	13068-033	
GEAR,KICKSTARTER (Ref # 16)	59051-1005	
RATCHET,KICK SHAFT (Ref # 17)	13078-011	
RATCHET,KICK SHAFT (Ref # 17)	13078-011	
SPRING RATCHET (Ref # 18)	92081-104	
CAP,KICKSTARTER (Ref # 19)	92102-008	
CIRCLIP,19MM (Ref # 20)	480J1900	
BOLT-UPSET 6X14 (Ref # 21)	112B0614	
BOLT-UPSET (Ref # 21)	112G0614	
WASHER-LOCK (Ref # 22)	92024-036	
STOPPER,KICKSTARTER (Ref # 23)	13072-012	