

1979 KZ750-B4 PARTS DIAGRAM

OIL PUMP/OIL FILTER

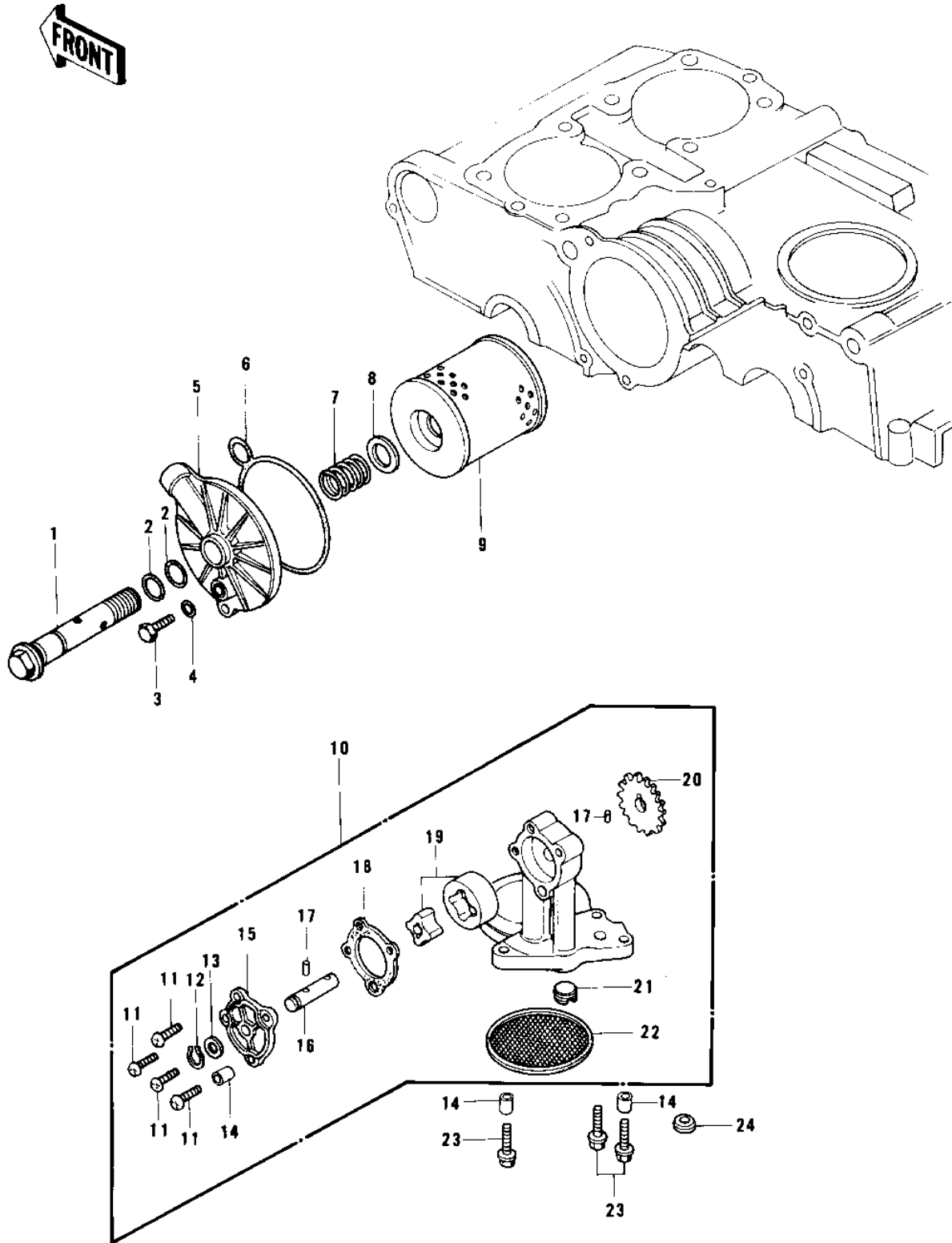

1979 KZ750-B4 PARTS LIST

OIL PUMP/OIL FILTER

ITEM NAME	PART NUMBER	QUANTITY
BOLT,OIL FILTER (Ref # 1)	92003-189	
"O" RING,16MM (Ref # 2)	670B2016	
PLUG,OIL DRAIN (Ref # 3)	92066-024	
"O" RING,8MM (Ref # 4)	670B1508	
COVER,OIL FILTER (Ref # 5)	16146-002	
"O" RING (Ref # 6)	92055-084	
SPRING,OIL FILTER (Ref # 7)	92081-1018	
WASHER,20.5X30X1.0 (Ref # 8)	92022-1012	
ELEMENT,OIL FILTER (Ref # 9)	16099-002	
OIL PUMP ASSY (Ref # 10)	16082-062	
SCREW PAN HEAD 6X25 (Ref # 11)	220B0625	
CIRCLIP,11MM (Ref # 12)	480J1100	
WASHER,PLAIN (Ref # 13)	92022-311	
PIN,DOWEL,8X10 (Ref # 14)	92043-1302	
COVER,OIL PUMP (Ref # 15)	16142-004	
SHAFT,OIL PUMP (Ref # 16)	16086-004	
PIN,DOWEL (Ref # 17)	92042-041	
GASKET,OIL PUMP (Ref # 18)	16145-003	
ROTOR ASSY,OIL PUMP (Ref # 19)	16154-003	
GEAR,OIL PUMP (Ref # 20)	16085-024	
SCREW,SLOTTED (Ref # 21)	92013-008	
STRAINER,OIL PUMP (Ref # 22)	16111-004	
BOLT,HEX HEAD,6X41 (Ref # 23)	92003-109	
O RING,0.D=18MM (Ref # 24)	92055-048	