

1976 KZ750-B1 PARTS DIAGRAM

CHASSIS ELECTRICAL EQUIPMENT

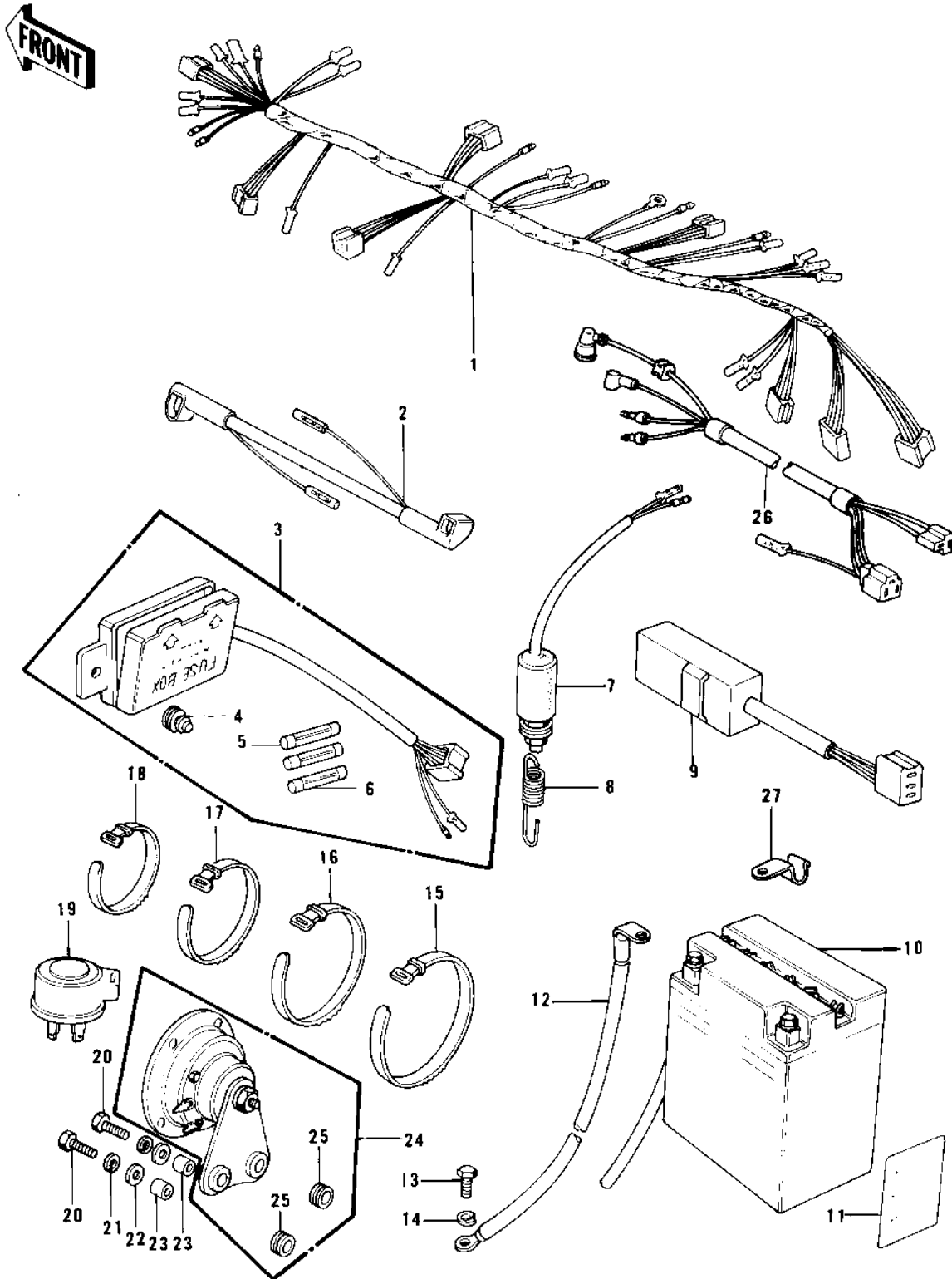

1976 KZ750-B1 PARTS LIST

CHASSIS ELECTRICAL EQUIPMENT

ITEM NAME	PART NUMBER	QUANTITY
WIRING HARNESS,MAIN (Ref # 1)	26001-128	1
WIRING HARNESS.MAIN (Ref # 1)	26001-148	1
WIRING HARNESS,MAIN (Ref # 1)	26001-1023	1
WIRING HARNESS,MAIN (Ref # 1)	26001-1062	1
WIRE,LEAD (Ref # 2)	26010-040	1
WIRE-LEAD,BATTERY (Ref # 2)	26011-1145	1
FUSE ASSY (Ref # 3)	26004-035	1
DAMPER RUBBER,FUSE (Ref # 4)	92075-279	1
FUSE-20A (Ref # 5)	26006-005	2
FUSE 10A (Ref # 6)	26006-003	3
SWITCH-BRAKE LAMP (Ref # 7)	27010-015	1
SPRING-BRAKE LAMP SW (Ref # 8)	27011-011	1
SWITCH,OUTAGE,INDICTR (Ref # 9)	28019-001	1
YUA BAT YB14L-A2 (Ref # 10)	26012-1008	1
LABEL-WARNING,BATTERY (Ref # 11)	56040-1036	1
WIRE,LEAD (Ref # 12)	26010-041	1
WIRE-LEAD,BATTERY (Ref # 12)	26011-1146	1
BOLT-UPSET,6X12 (Ref # 13)	112G0612	1
WASHER SPRING 6MM (Ref # 14)	461F0600	1
BAND,LONG (Ref # 15)	92072-032	10
BAND,WIRING HARNESS (Ref # 16)	92072-056	10
BAND,WIRING HARNESS (Ref # 16)	92072-056	3
BAND,MIDDLE (Ref # 17)	92072-031	10
BAND,SHORT (Ref # 18)	92072-030	10
BAND,SHORT (Ref # 18)	92072-030	4
RELAY-TURN SIGNAL (Ref # 19)	27002-011	1
BOLT-SMALL-UPSET 8X25 (Ref # 20)	115G0825	2
BOLT HEX HEAD 8X28 (Ref # 20)	114G0828	2
WASHER SPRING 8MM (Ref # 21)	461F0800	2

1976 KZ750-B1 PARTS LIST

CHASSIS ELECTRICAL EQUIPMENT

ITEM NAME	PART NUMBER	QUANTITY
WASHER PLAIN 8MM (Ref # 22)	411B0800	2
COLLAR,HORN FITTING (Ref # 23)	92027-271	2
HORN (Ref # 24)	27003-074	1
DAMPER RUBBER,HORN MO (Ref # 25)	92075-294	2
WIRING HARNESS (Ref # 26)	26001-1024	1
CLAMP (Ref # 27)	92037-1044	1