

1975 Z1 PARTS DIAGRAM

OIL PUMP/OIL FILTER/OIL PAN

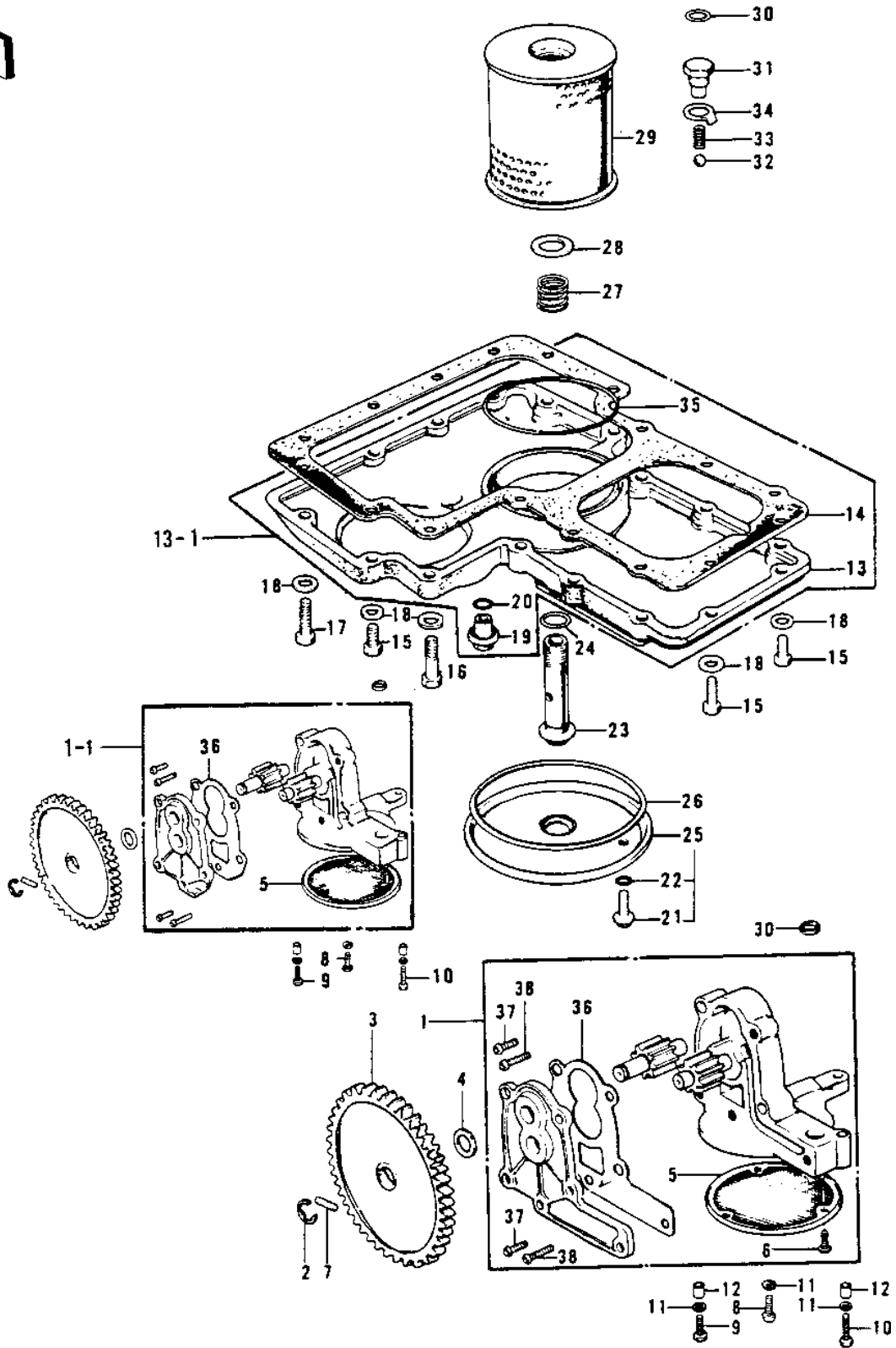

1975 Z1 PARTS LIST

OIL PUMP/OIL FILTER/OIL PAN

ITEM NAME	PART NUMBER	QUANTITY
OIL PUMP ASSY (Ref # 1)	16082-036	
PUMP-ASSY-OIL (Ref # 1-1)	16082-5001	
CIRCLIP,7MM (Ref # 2)	482K7000	
GEAR,OIL PUMP 49T (Ref # 3)	16085-019	
WASHER,LOCK,16MM (Ref # 4)	92026-080	
STRAINER,OIL (Ref # 5)	16111-002	
STRAINER,OIL PUMP (Ref # 5)	16111-004	
SCREW PAN HEAD 5X8 (Ref # 6)	220B0508	
PIN,DOWEL,3X14 (Ref # 7)	551A0314	
BOLT-UPSET (Ref # 8)	112G0622	
BOLT,FLANGED,6X22 (Ref # 8)	92001-1352	
BOLT-UPSET,6X35 (Ref # 9)	112G0635	
BOLT,HEX HEAD,6X35 (Ref # 9)	92001-164	
BOLT-UPSET (Ref # 10)	112G0645	
BOLT,HEX HEAD,6X45 (Ref # 10)	92001-165	
WASHER PLAIN 6MM (Ref # 11)	410B0600	
PIN-DOWEL (Ref # 12)	92042-007	
PAN-OIL (Ref # 13)	49034-5020	
PAN-OIL (Ref # 13-1)	49034-5020	
GASKET,OIL PAN (Ref # 14)	11060-1074	
BOLT-UPSET (Ref # 15)	112G0625	
BOLT,FLANGED,6X25 (Ref # 15)	130G0625	
BOLT 6X35 (Ref # 16)	110R0635	
BOLT, HEX HEAD, 6X34 (Ref # 16)	92003-159	
BOLT,HEX HEAD,6X50 (Ref # 17)	110G0650	
BOLT-FLANGED,6X50 (Ref # 17)	130G0650	
WASHER PLAIN 6MM (Ref # 18)	410B0600	
PLUG,OIL DRAIN (Ref # 19)	92001-1183	
"O" RING,22MM (Ref # 20)	670B2022	

1975 Z1 PARTS LIST

OIL PUMP/OIL FILTER/OIL PAN

ITEM NAME	PART NUMBER	QUANTITY
PLUG,OIL DRAIN (Ref # 21)	92066-024	
"O" RING,8MM (Ref # 22)	670B1508	
BOLT,OIL FILTER (Ref # 23)	92001-1074	
BOLT,OIL FILTER (Ref # 23)	92001-1074	
"O" RING,22MM (Ref # 24)	670B2022	
COVER,OIL FILTER (Ref # 25)	14025-1112	
"O" RING,105MM (Ref # 26)	671B25105	
SPRING,OIL FILTER (Ref # 27)	92081-1018	
WASHER,20.5X30X1.0 (Ref # 28)	92022-1012	
ELEMENT,OIL FILTER (Ref # 29)	16099-002	
O RING,0.D=18MM (Ref # 30)	92055-048	
BOLT (Ref # 31)	92003-095	
BALL STEEL 3/8' (Ref # 32)	600A1200	
SPRING (Ref # 33)	92081-109	
WASHER,LOCK (Ref # 34)	92024-048	
"O" RING,91MM (Ref # 35)	92055-052	
GASKET,OIL PUMP (Ref # 36)	16145-001	
GASKET,OIL PUMP (Ref # 36)	11009-1029	
SCREW PAN HEAD 6X16 (Ref # 37)	220B0616	
SCREW PAN HEAD 6X28 (Ref # 38)	220B0628	