

1979 Police 1000 PARTS DIAGRAM

CLUTCH ('79-'81 C2/C3/C4)

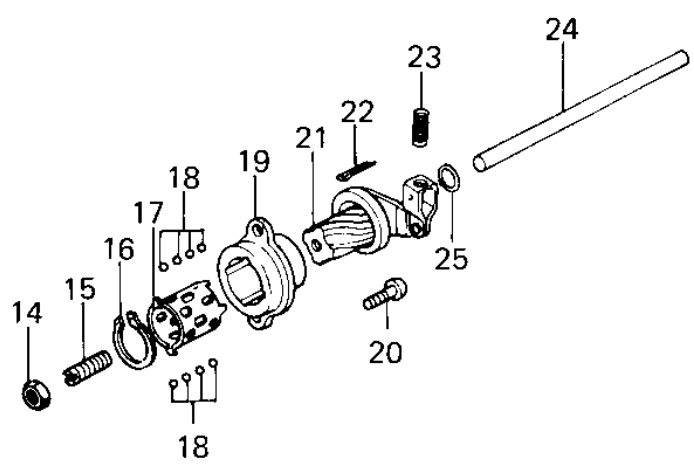
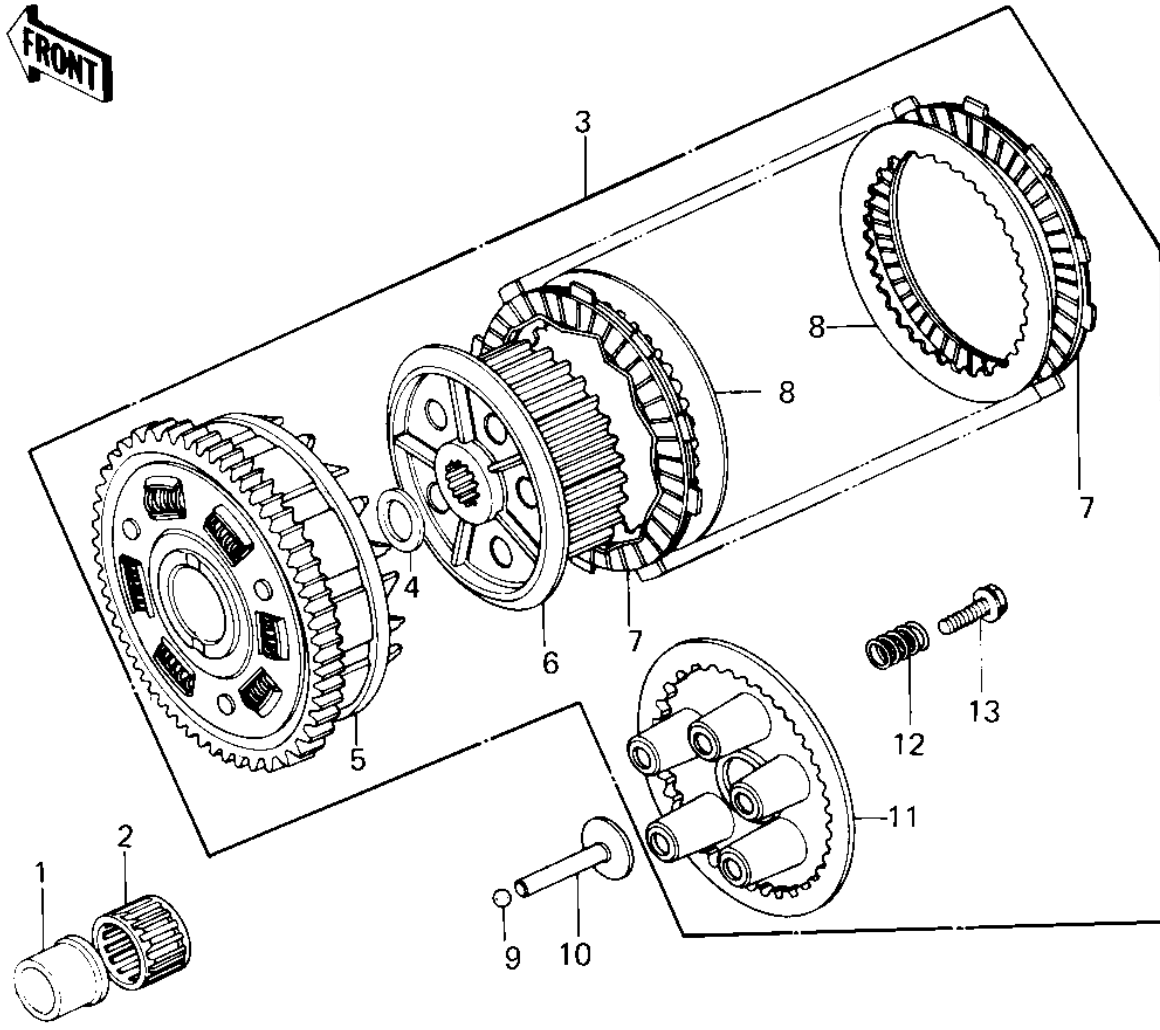

102

1979 Police 1000 PARTS LIST

CLUTCH ('79-'81 C2/C3/C4)

ITEM NAME	PART NUMBER	QUANTITY
BUSHING,CLUTCH (Ref # 1)	92028-135	1
BEARING,KTV323723 (Ref # 2)	92046-028	1
CLUTCH-ASSY (Ref # 3)	13081-1014	1
WASHER TH 25.5X47X2. (Ref # 4)	92026-022	1
CLUTCH-ASSY (Ref # 5)	13081-1367	1
CLUTCH-ASSY (Ref # 6)	13081-1367	1
PLATE,CLUTCH FRICTIO (Ref # 7)	13088-030	8
PLATE,CLUTCH STEEL (Ref # 8)	13089-022	7
BALL STEEL 3/8' (Ref # 9)	600A1200	1
PUSHER,CLUTCH SPRG P (Ref # 10)	13116-022	1
PLATE,CLUTCH SPRING (Ref # 11)	13187-006	1
SPRING,CLUTCH (Ref # 12)	92081-1033	5
BOLT,CLUTCH SPR FITT (Ref # 13)	92001-1066	5
NUT 8MM (Ref # 14)	318B0800	1
SCREW,SLOTTED,8X25 (Ref # 15)	92014-014	1
CIRCLIP 15MM (Ref # 16)	480J1500	1
RETAINER (Ref # 17)	13197-004	1
BALL,STEEL,1/8" (Ref # 18)	600A0400	11
OUTER,CLUTCH RELEASE (Ref # 19)	13118-011	1
SCREW PAN HEAD 6X16 (Ref # 20)	220B0616	2
INNER,CLUTCH RELEASE (Ref # 21)	13102-019	1
PIN COTTER 1.6X15 (Ref # 22)	550D1615	1
SPRING-CLUTCH RELEAS (Ref # 23)	92081-069	1
PUSH ROD,CLUTCH (Ref # 24)	13116-021	1
"O" RING,7MM (Ref # 25)	670B1507	1