

1981 LTD PARTS DIAGRAM

CYLINDER HEAD

E1111-0030

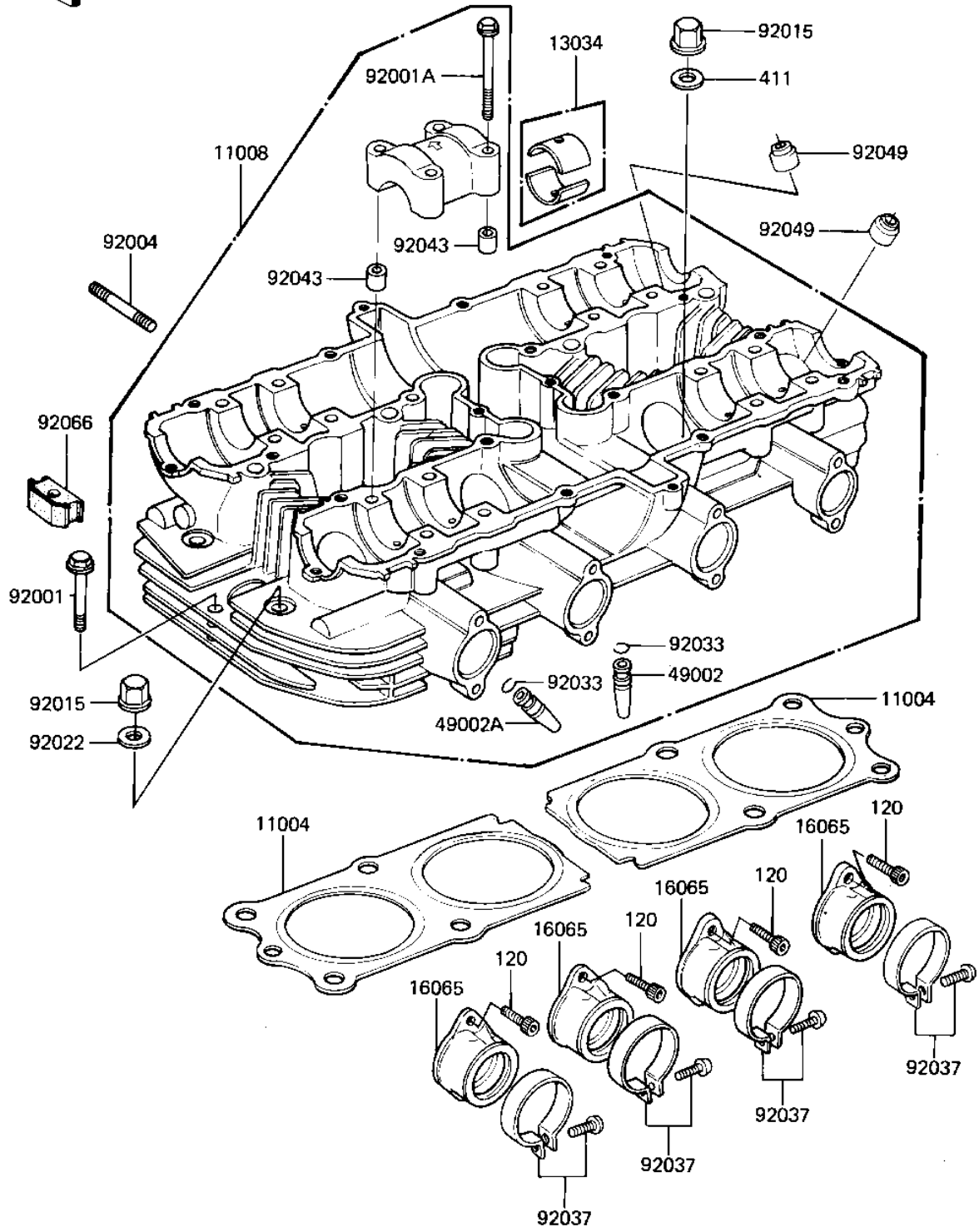

1981 LTD PARTS LIST

CYLINDER HEAD

ITEM NAME	PART NUMBER	QUANTITY
GASKET-HEAD (Ref # 11004)	11004-1222	2
HEAD-COMP-CYLINDER,W (Ref # 11008)	11008-1013	1
BUSHING,CAMSHAFT (Ref # 13034)	13034-030	16
HOLDER-CARBURETOR (Ref # 16065)	16065-1135	4
GUIDE,INLET VALVE (Ref # 49002)	12013-009	4
GUIDE,EXHAUST VALVE (Ref # 49002A)	49002-1002	4
BOLT,HEX HEAD,6X45 (Ref # 92001)	92003-092	2
BOLT,6X43 (Ref # 92001A)	92002-1881	16
STUD,8X30 (Ref # 92004)	92004-1069	8
NUT,CYLINDER HEAD (Ref # 92015)	92015-076	12
WASHER,10.5X22X1.6 (Ref # 92022)	92022-1005	4
CIRCLIP-VALVE (Ref # 92033)	92036-023	8
CLAMP,53M/M (Ref # 92037)	92037-201	4
PIN-DOWEL (Ref # 92043)	92042-007	8
OIL SEAL,RV37129.5 (Ref # 92049)	92049-016	8
PLUG,CYLNDR HD COVER (Ref # 92066)	92066-1106	4
BOLT-SOCKET,6X16,BLA (Ref # 120)	120S0616	8
WASHER PLAIN 10MM (Ref # 411)	411B1000	8