

1982 KZ1000-J2 PARTS DIAGRAM

CYLINDER HEAD COVER

E1112-0047

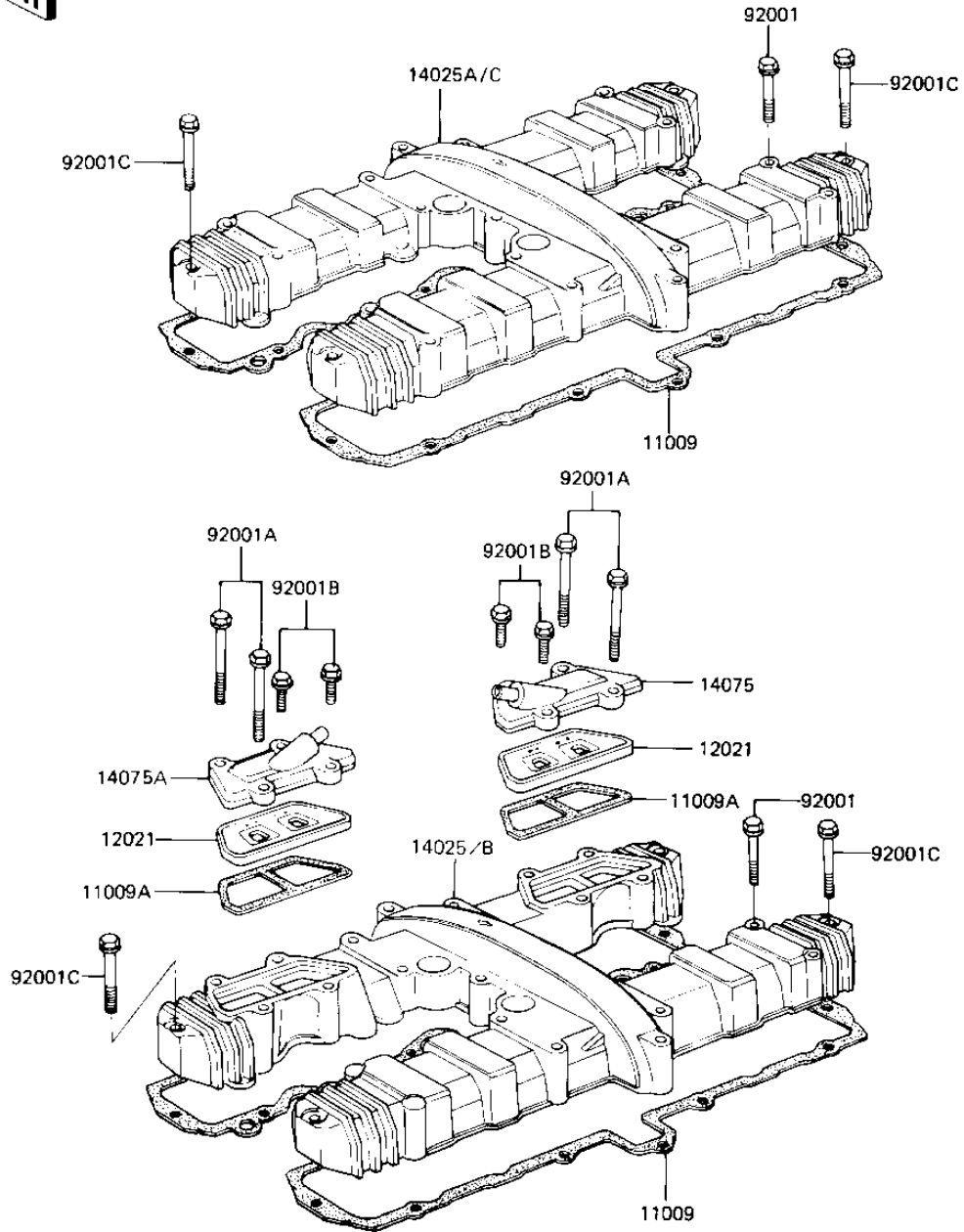

1982 KZ1000-J2 PARTS LIST

CYLINDER HEAD COVER

ITEM NAME	PART NUMBER	QUANTITY
GASKET,CYLINDER HEAD (Ref # 11009)	11009-1205	1
GASKET,REED VALVE (Ref # 11009A)	11060-1066	2
VALVE-ASSY-REED (Ref # 12021)	12021-1008	2
COVER,CYLINDER HEAD,B (Ref # 14025)	14025-1463	1
COVER,SEAT LOCK (Ref # 14025A)	14025-1246	1
COVER,CYLINDER HEAD,B (Ref # 14025B)	14025-1463	1
COVER,CYLINDER HEAD,B (Ref # 14025C)	14025-1464	1
CAP-ASSY,REED VALVE,R (Ref # 14075)	14075-5012	1
CAP-ASSY,REED VALVE,L (Ref # 14075A)	14075-5013	1
BOLT,FLANGED,6X45 (Ref # 92001)	92001-1350	20
BOLT,FLANGED,6X45 (Ref # 92001)	92001-1350	16
BOLT,FLANGED,6X70 (Ref # 92001A)	92001-1351	4
BOLT,FLANGED,6X22 (Ref # 92001B)	92001-1352	4
BOLT,FLANGED,6X52 (Ref # 92001C)	92001-1353	4