

1982 KZ1000-J2 PARTS DIAGRAM

GEAR CHANGE MECHANISM

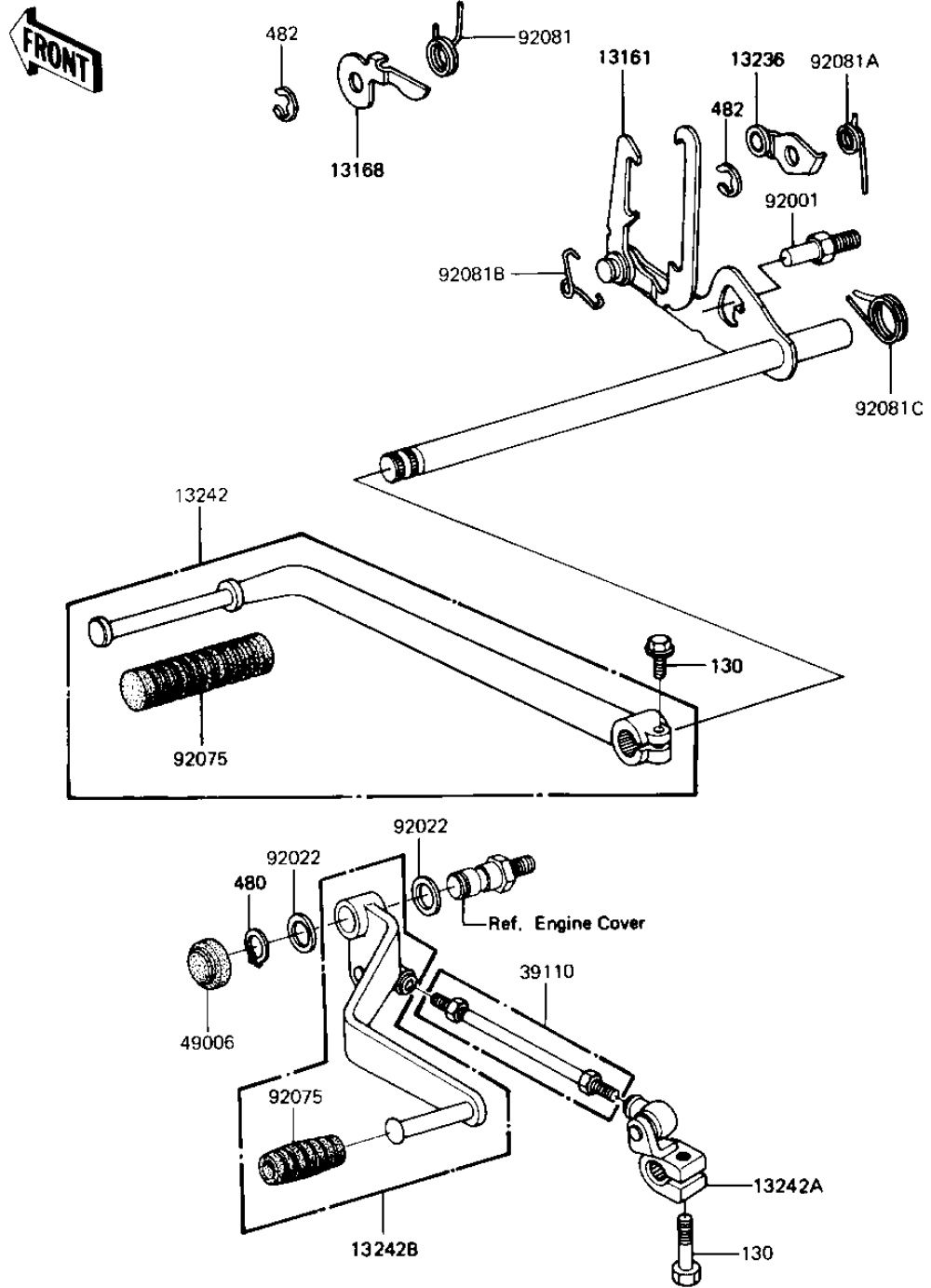

1982 KZ1000-J2 PARTS LIST

GEAR CHANGE MECHANISM

ITEM NAME	PART NUMBER	QUANTITY
LEVER-COMP-CHANGE SHA (Ref # 13161)	13161-1023	1
LEVER,GEAR POSITIONIN (Ref # 13168)	13168-1074	1
LEVER-COMP,NEUTRAL PO (Ref # 13236)	13236-1029	1
PEDAL ASSY,GEAR CHANG (Ref # 13242)	13242-006	1
BOLT,RETURN SPRING (Ref # 92001)	92001-1401	1
RUBBER CHANGE PEDAL (Ref # 92075)	13157-004	1
SPRING,POSITIONING LE (Ref # 92081)	92081-1284	1
SPRING (Ref # 92081A)	92081-1285	1
SPRING,KICK PAWL (Ref # 92081B)	92083-018	1
SPRING,CHG PEDL RTRN (Ref # 92081C)	92083-028	1
BOLT-FLANGED,6X20 (Ref # 130)	130P0620	1
CIRCLIP 6MM (Ref # 482)	482J6000	2