

1982 KZ1000-J2 PARTS DIAGRAM

SWING ARM/SHOCK ABSORBERS

F2140-0143

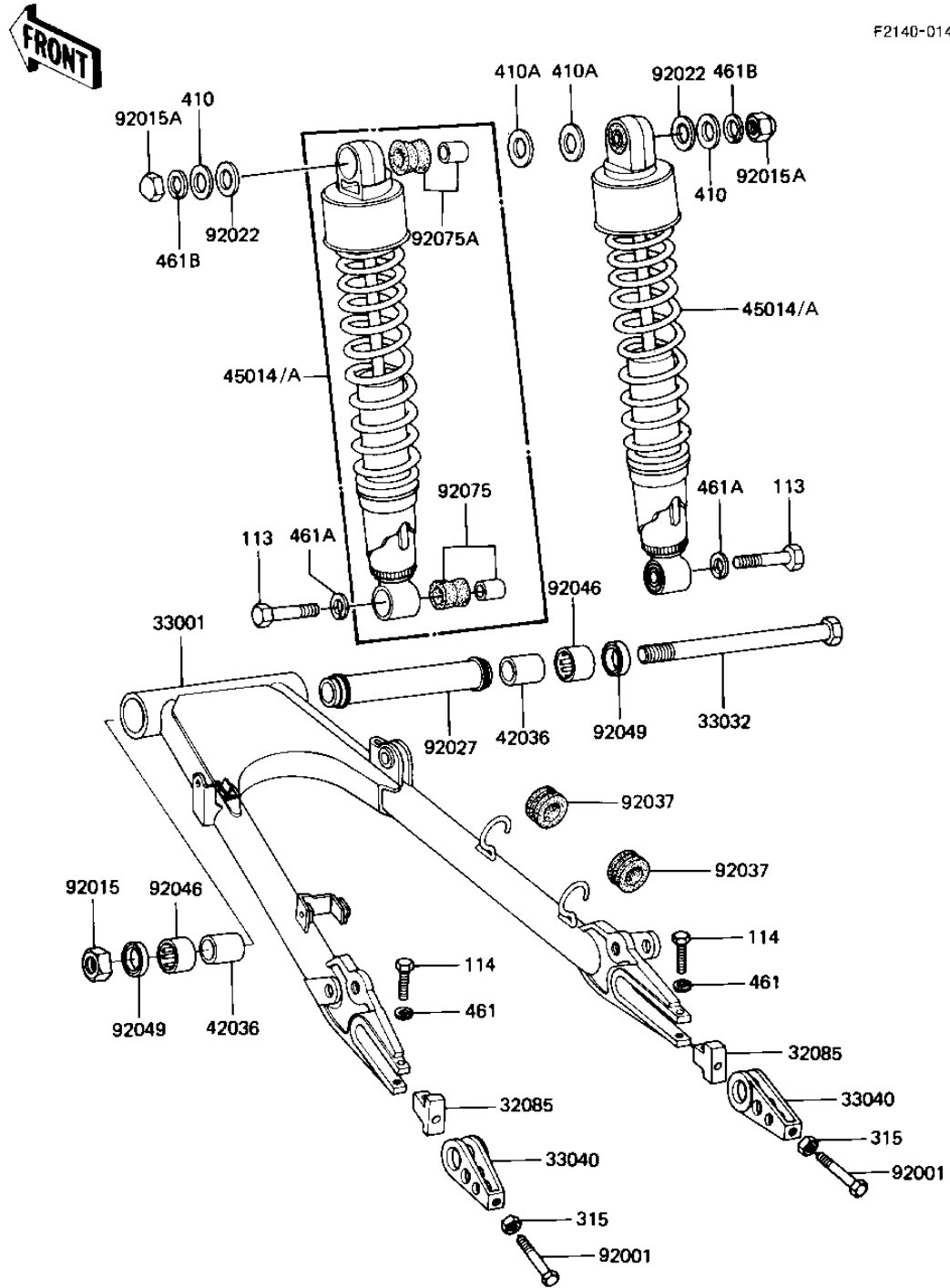

1982 KZ1000-J2 PARTS LIST

SWING ARM/SHOCK ABSORBERS

ITEM NAME	PART NUMBER	QUANTITY
STOPPER,CHAIN ADJUST (Ref # 32085)	33044-001	2
ARM-COMP-SWING (Ref # 33001)	33001-1071	1
SHAFT,SWING ARM PIVOT (Ref # 33032)	33032-036	1
ADJUSTER,CHAIN (Ref # 33040)	33040-066	2
SLEEVE,SWING ARM (Ref # 42036)	42036-1040	2
SHOCK ABSBR RR (Ref # 45014)	45014-1076	2
BOLT-CHN ADJUST 10MM (Ref # 92001)	92001-143	2
NUT-SELF LOCKING (Ref # 92015)	92019-012	1
NUT 12MM (Ref # 92015A)	92020-014	2
WASHER,12.4X28X2.3 (Ref # 92022)	92022-1239	2
COLLAR (Ref # 92027)	92027-1561	1
DAMPER RUBBER (Ref # 92037)	43064-007	2
BEARING-NEEDLE (Ref # 92046)	92046-1035	2
SEAL-OIL (Ref # 92049)	92049-1060	2
BUSHING,SHOCK ABSORBE (Ref # 92075)	45017-019	2
BUSHING,SHOCK ABSORBE (Ref # 92075A)	92075-1141	2
BOLT HEX HEAD 10X35 (Ref # 113)	113N1035	2
BOLT,8X40 (Ref # 114)	115G0840	2
NUT 10MM (Ref # 315)	315B1000	2
WASHER PLAIN 12MM (Ref # 410)	410B1200	2
WASHER PLAIN 14MM (Ref # 410A)	410B1400	2
WASHER SPRING 8MM (Ref # 461)	461F0800	2
WASHER SPRING 10MM (Ref # 461A)	461F1000	2
WASHER SPRING 12MM (Ref # 461B)	461F1200	2