

# 1983 Shaft PARTS DIAGRAM

CAMSHAFTS/CHAIN/TENSIONER

E1230-0019

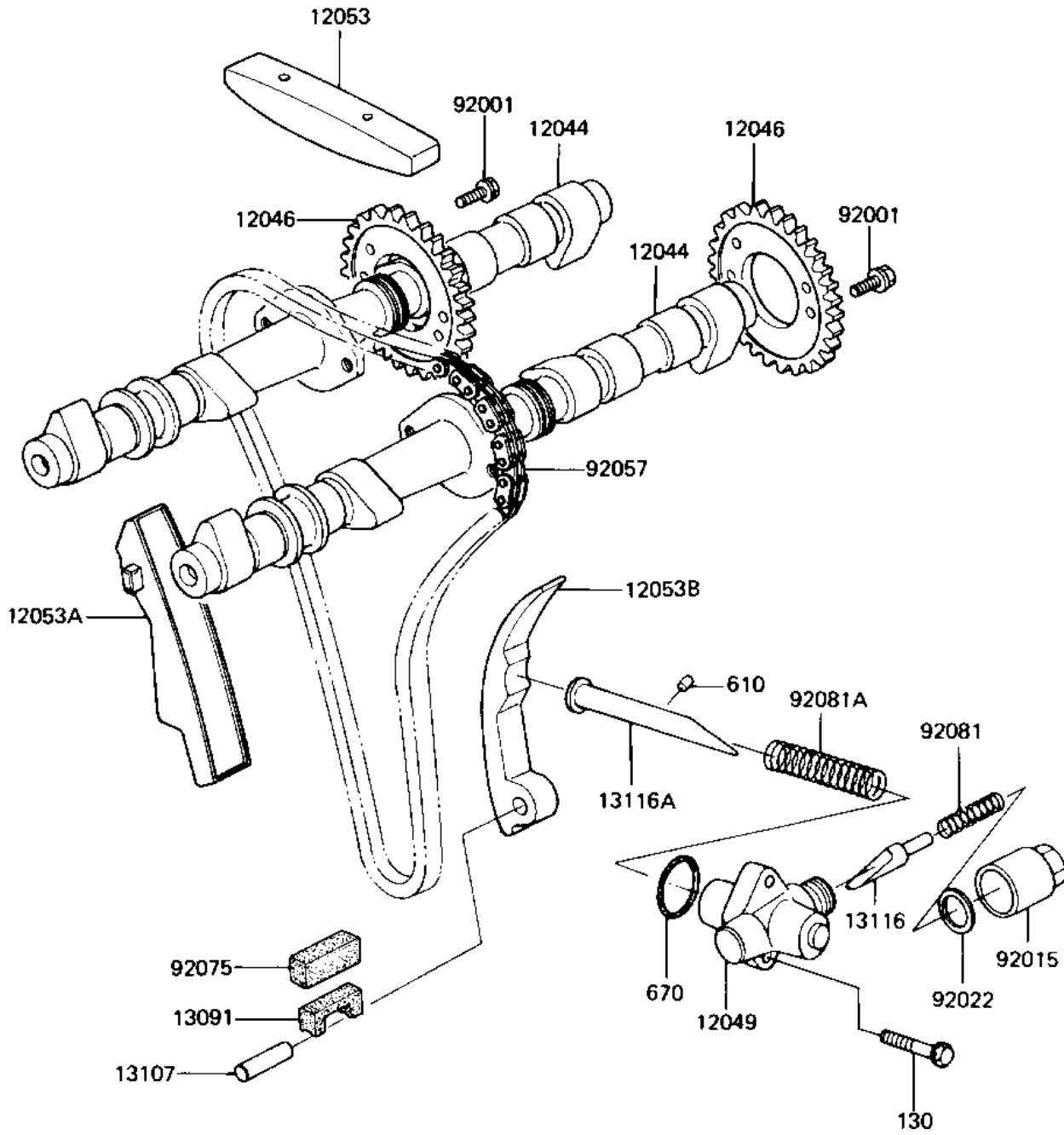

# 1983 Shaft PARTS LIST

## CAMSHAFTS/CHAIN/TENSIONER

ITEM NAME	PART NUMBER	QUANTITY
CAMSHAFT-VALVE (Ref # 12044)	12044-1027	2
SPROCKET,CAMSHAFT EXH (Ref # 12046)	12046-1025	2
TENSIONER,CAM CHAIN (Ref # 12049)	12049-1009	1
GUIDE,CAM CHAIN,HEAD (Ref # 12053)	12053-1018	1
GUIDE-CHAIN,CAM,FR (Ref # 12053A)	12053-1048	1
GUIDE-CHAIN,CAM,RR (Ref # 12053B)	12053-1049	1
HOLDER,CAM CHAIN GUID (Ref # 13091)	13091-1084	1
SHAFT,8X28 (Ref # 13107)	13107-1020	1
ROD,PUSH,CAM CHAIN (Ref # 13116)	13116-1012	1
ROD-PUSH,TENSIONER (Ref # 13116A)	13116-1038	1
BOLT,SPROCKET FITTING (Ref # 92001)	92003-208	4
CAP,TENSIONER,18M/M (Ref # 92015)	92015-1100	1
WASHER,18.3X24X1.4T (Ref # 92022)	92022-1175	1
CHAIN,CAMSHAFT,75-010 (Ref # 92057)	92057-1052	1
DAMPER (Ref # 92075)	92075-1270	1
SPRING,TENSIONER (Ref # 92081)	92081-1302	1
SPRING,TENSIONER (Ref # 92081A)	92081-1380	1
BOLT,FLANGED,6X25 (Ref # 130)	130G0625	2
PIN DOWEL 4X8 (Ref # 610)	610A0408	1
"O" RING,22M/M (Ref # 670)	670E2022	1