

1983 Shaft PARTS DIAGRAM

CRANKCASE BOLT & STUD PATTERN

E1412-0008

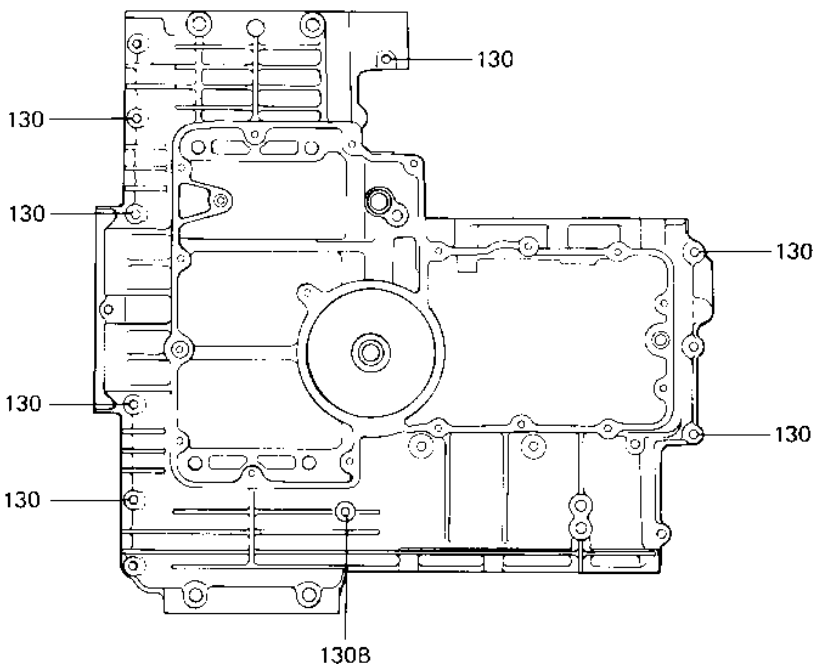
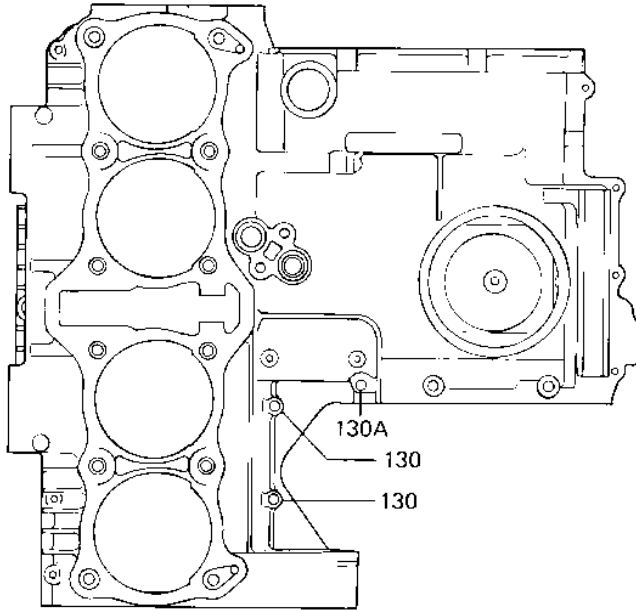

1983 Shaft PARTS LIST

CRANKCASE BOLT & STUD PATTERN

ITEM NAME	PART NUMBER	QUANTITY
BOLT,FLANGED,6X40 (Ref # 130)	130G0640	9
BOLT-FLANGED,6X50 (Ref # 130A)	130G0650	1
UNAVAILABLE IN PRICE BOOK (Ref # 130B)	13060695	1