

1983 Shaft PARTS DIAGRAM

TRANSMISSION

E1361-0089

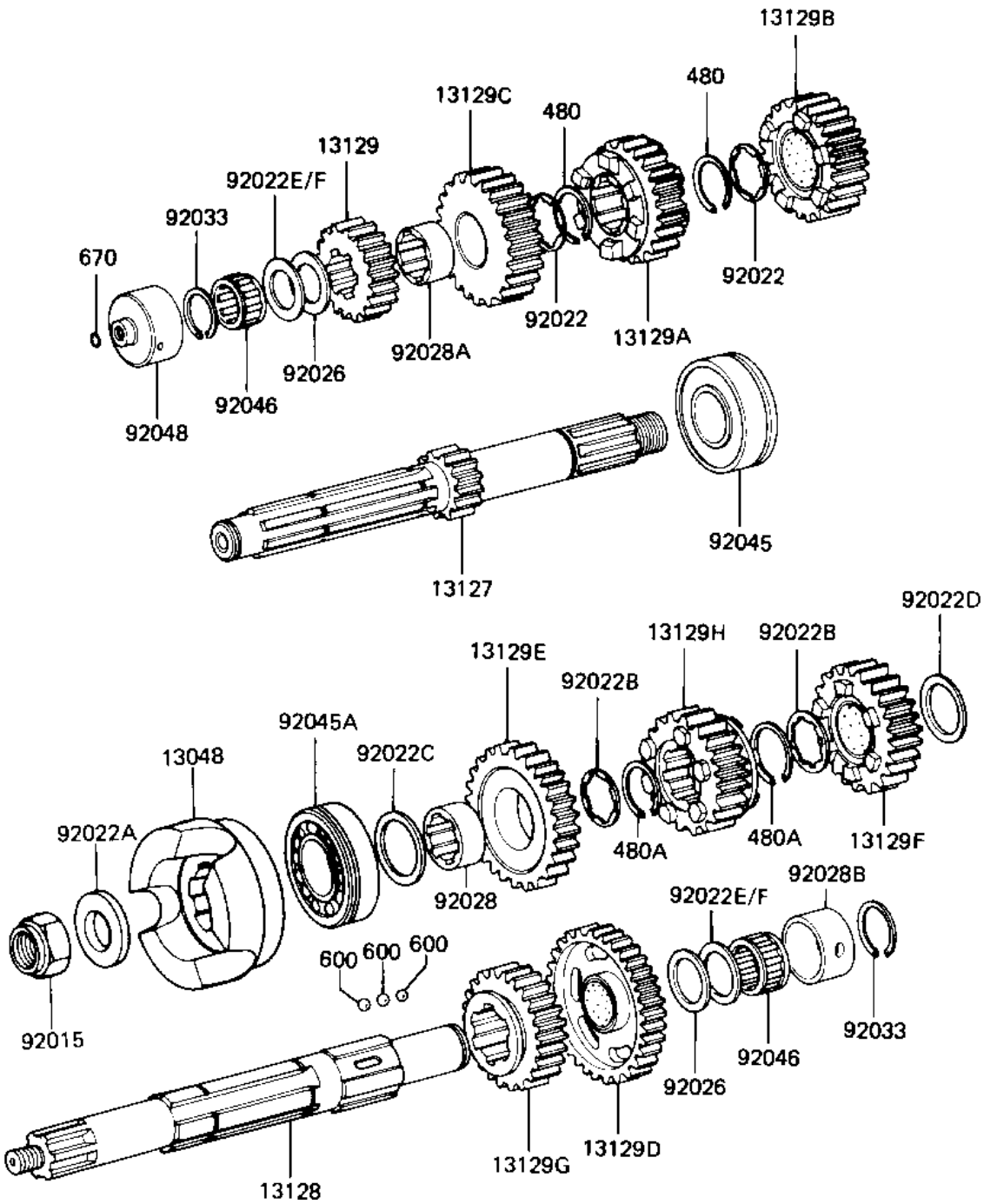

1983 Shaft PARTS LIST

TRANSMISSION

ITEM NAME	PART NUMBER	QUANTITY
DAMPER,OUTPUT SHAFT (Ref # 13048)	13048-1004	1
SHAFT-TRANSMISSION IN (Ref # 13127)	13127-1038	1
UNAVAILABLE IN PRICE BOOK (Ref # 13128)	13128-1235	1
INPUT 2ND,18T (Ref # 13129)	13129-1235	1
INPUT 3RD,21T (Ref # 13129A)	13129-1236	1
INPUT 4TH,23T (Ref # 13129B)	13129-1237	1
INPUT TOP,25T (Ref # 13129C)	13129-1238	1
OUTPUT LOW,37T (Ref # 13129D)	13129-1239	1
OUTPUT 2ND,33T (Ref # 13129E)	13129-1240	1
OUTPUT 3RD,30T (Ref # 13129F)	13129-1241	1
OUTPUT 4TH,27T (Ref # 13129G)	13129-1242	1
OUTPUT TOP,26T (Ref # 13129H)	13129-1243	1
NUT,14M/M (Ref # 92015)	92015-1067	1
WASHER,LOCK (O.D=35) (Ref # 92022)	92022-1077	2
WASHER,PLAIN,5X14.1 (Ref # 92022A)	92022-1115	1
WASHER,LOCK,30X42X1.4 (Ref # 92022B)	92022-1218	2
WASHER,LOCK (O.D=35) (Ref # 92022C)	92022-1077	1
WASHER,32.3X42X3 (Ref # 92022D)	92022-1220	1
WASHER,PLAIN,22MM (Ref # 92022E)	92022-212	2
WASHER,PLAIN,22MM (Ref # 92022F)	92022-213	AR
SPACER (I.D=22 O.D=35 (Ref # 92026)	92026-1020	2
BUSHING,2ND GEAR (Ref # 92028)	92028-1112	1
BUSHING,TOP GEAR (Ref # 92028A)	92028-1124	1
BUSH,OUTPUT SHAFT (Ref # 92028B)	92028-123	1
CIRCLIP,25MM (Ref # 92033)	92033-025	2
BEARING,BALL,5305NSH2 (Ref # 92045)	92045-1028	1
BEARING-BALL,63/28NC3 (Ref # 92045A)	92045-1034	1
BEARING,PK223013.8 (Ref # 92046)	92046-031	2
RACE,DRIVE SHAFT BRNG (Ref # 92048)	92048-1012	1

1983 Shaft PARTS LIST

TRANSMISSION

ITEM NAME	PART NUMBER	QUANTITY
CIRCLIP 28MM (Ref # 480)	480J2800	2
CIRCRIP-TYPE-C (Ref # 480A)	480J3200	2
BALL STEEL 3/16' (Ref # 600)	600A0600	3
"O" RING,8MM (Ref # 670)	670B1508	1