

1982 Shaft PARTS DIAGRAM

CARBURETOR PARTS (KZ1100-A1/A2)

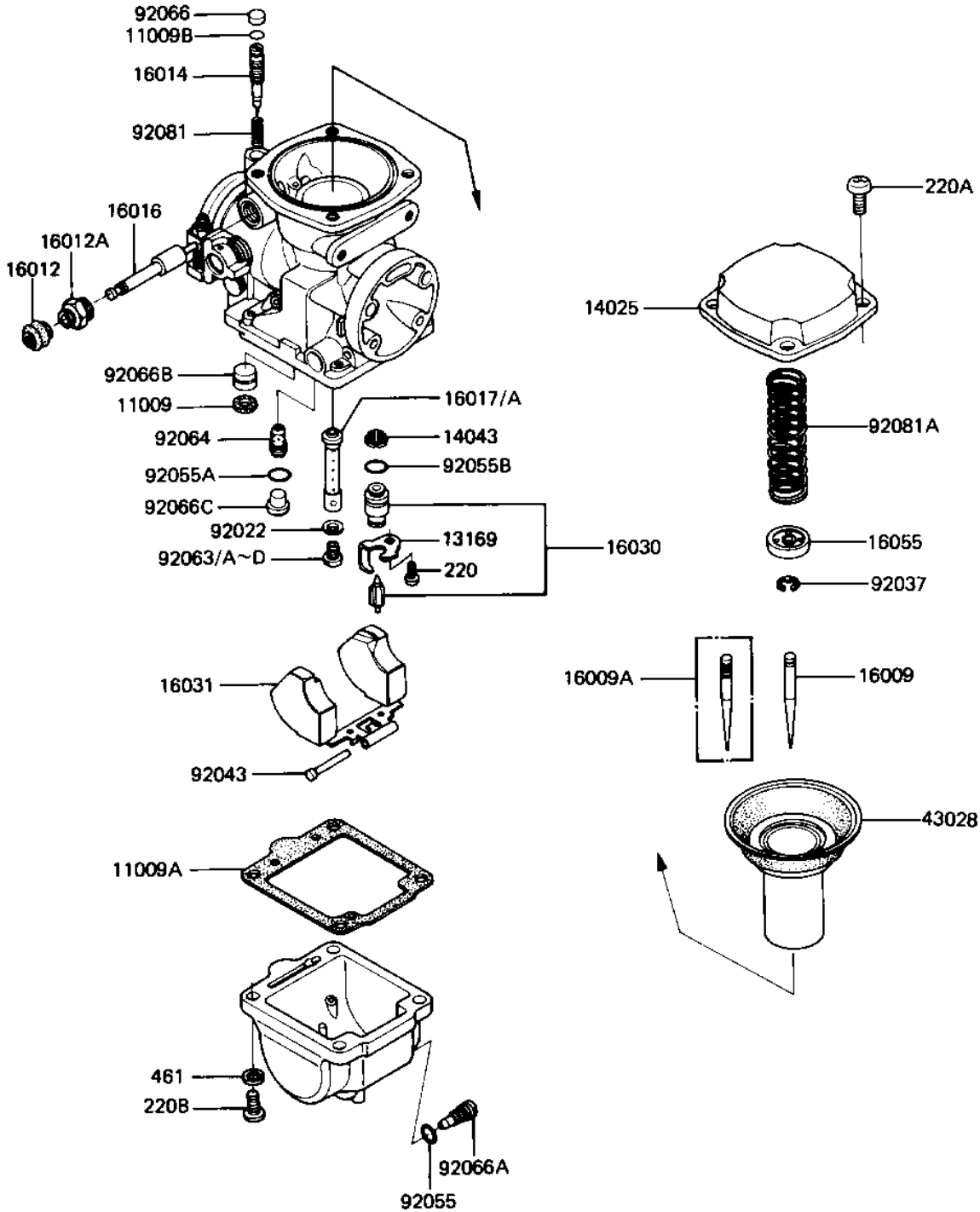

E1612-0058



1982 Shaft PARTS LIST

CARBURETOR PARTS (KZ1100-A1/A2)

ITEM NAME	PART NUMBER	QUANTITY
GASKET,CARB. PLUG (Ref # 11009)	11009-1240	4
GASKET,FLOAT CHAMBER (Ref # 11009A)	11009-1241	4
"O" RING (Ref # 11009B)	16038-022	4
PLATE (Ref # 13169)	13169-1482	4
TOP-CHAMBER,MIXING (Ref # 14025)	14025-1359	4
FILTER,FLOAT VALVE (Ref # 14043)	14043-1010	4
NEEDLE JET (Ref # 16009)	16009-1088	4
NEEDLE-JET (Canada) (Ref # 16009A)	16009-1089	4
CAP-STARTER PLUNGER (Ref # 16012)	16012-1010	4
CAP-STARTER PLUNGER (Ref # 16012A)	16012-1011	4
SCREW-PILOT AIR (Ref # 16014)	16014-1014	4
PLUNGER (Ref # 16016)	16016-1019	4
JET-NEEDLE (Ref # 16017)	16017-1086	4
JET-NEEDLE (Canada) (Ref # 16017A)	16017-1087	4
VALVE-FLOAT (Ref # 16030)	16030-1016	4
FLOAT (Ref # 16031)	16031-1013	4
PLATE,NEEDLE (Ref # 16055)	16055-010	4
DIAPHRAGM,VALVE (Ref # 43028)	43028-1025	4
WASHER MAIN JET (Ref # 92022)	16034-001	4
CIRCLIP (Ref # 92037)	16008-014	4
PIN,FLOAT (Ref # 92043)	16032-008	4
"O" RING (Ref # 92055)	92055-044	4
"O" RING,CHECK VALVE (Ref # 92055A)	92055-1059	4
"O" RING (Ref # 92055B)	92055-1105	4
JET-MAIN,#A122.5 (Ref # 92063)	92063-1101	4
JET-MAIN,#A125 (Ref # 92063A)	92063-1102	4
JET-MAIN,#A120 (Ref # 92063B)	92063-1106	4
JET-MAIN,#117.5 (Ref # 92063C)	92063-1107	4
MAIN JET,A115 (Ref # 92063D)	92063-1109	4

1982 Shaft PARTS LIST

CARBURETOR PARTS (KZ1100-A1/A2)

ITEM NAME	PART NUMBER	QUANTITY
JET-PILOT,#A37.5 (Ref # 92064)	92064-1036	4
PLUG,PILOT SCREW (Ref # 92066)	92066-1051	4
SCREW,DRAIN (Ref # 92066A)	92066-1064	4
PLUG,CARBURETOR (Ref # 92066B)	92066-1086	4
PLUG,PILOT JET (Ref # 92066C)	92066-1087	4
SPRING,PILOT SCREW (Ref # 92081)	16022-016	4
SPRING,DPHRGM VALVE (Ref # 92081A)	92081-1363	4
SCREW PAN HEAD 4X6 (Ref # 220)	220B0406	4
SCREW PAN HEAD 5X10 (Ref # 220A)	220B0510	14
SCREW-PAN-CROS (Ref # 220B)	220B0514	16
WASHER SPRING 5MM (Ref # 461)	461F0500	16