

1981 Shaft PARTS DIAGRAM

GENERATOR/REGULATOR

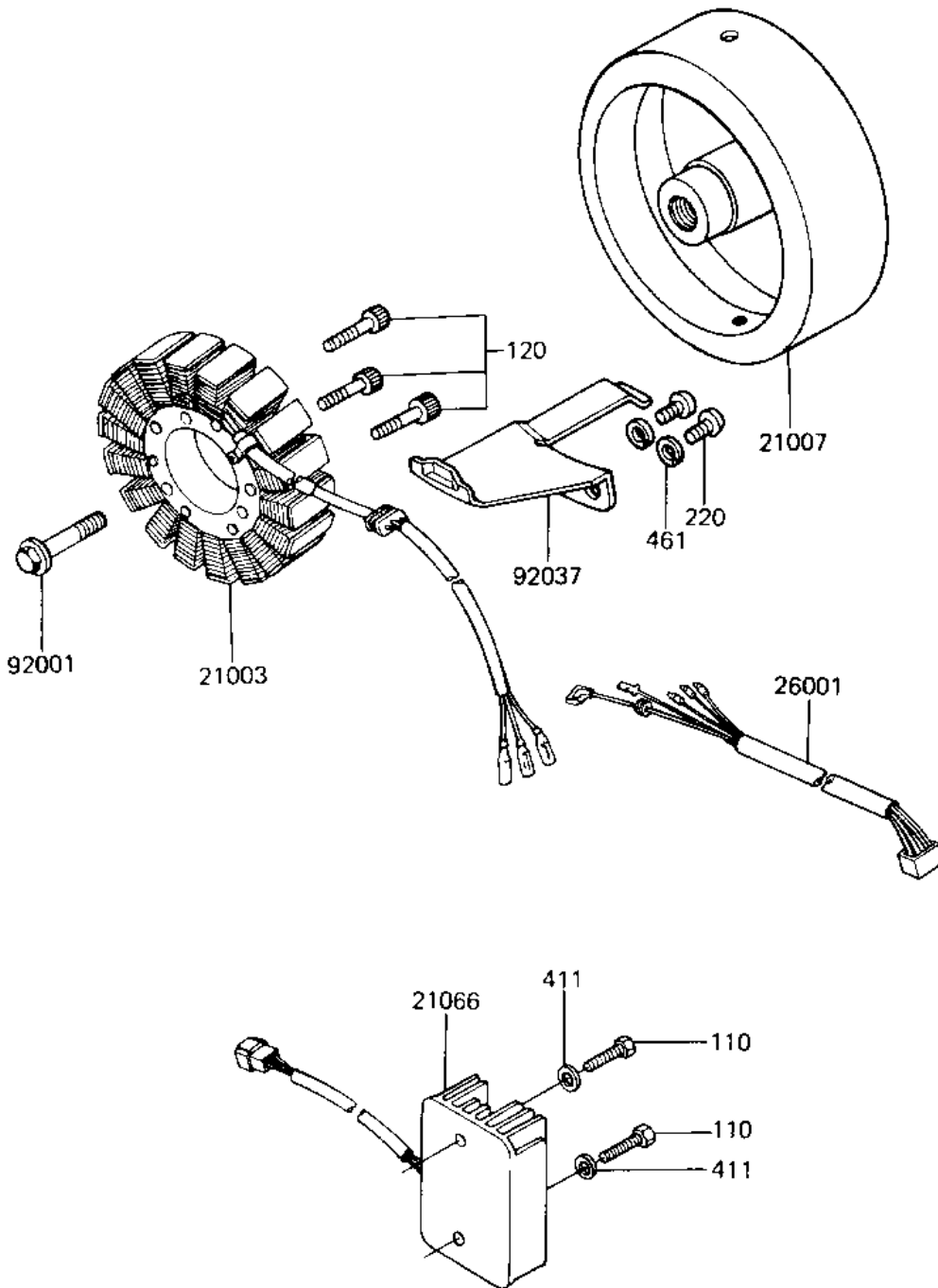

E1810-0012



1981 Shaft PARTS LIST

GENERATOR/REGULATOR

ITEM NAME	PART NUMBER	QUANTITY
STATOR (Ref # 21003)	21003-1040	1
ROTOR (Ref # 21007)	21007-1036	1
REGULATOR-VOLTAGE (Ref # 21066)	21066-1018	1
HARNESS,GENERATOR (Ref # 26001)	26001-1224	1
BOLT,12X40 (Ref # 92001)	92001-1146	1
CLAMP (Ref # 92037)	92037-1214	1
BOLT-UPSET 6X14 (Ref # 110)	112B0614	2
BOLT,SOCKET,6X30 (Ref # 120)	120P0630	3
SCREW PAN HEAD 5X12 (Ref # 220)	220B0512	2
WASHER PLAIN 6MM (Ref # 411)	411B0600	2
WASHER SPRING 5MM (Ref # 461)	461F0500	2