

1983 Shaft PARTS DIAGRAM

FRAME FITTINGS

F2131-0125

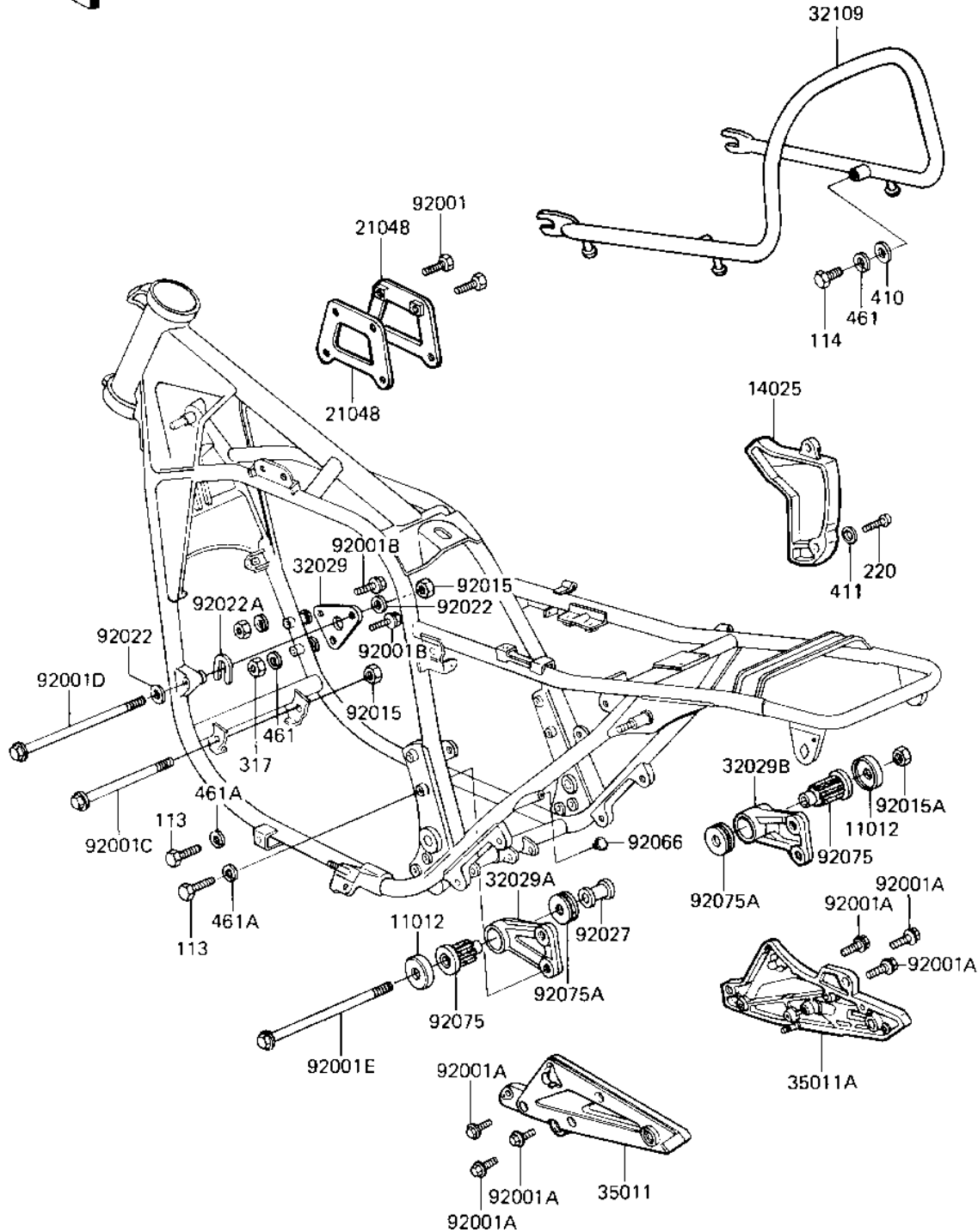

1983 Shaft PARTS LIST

FRAME FITTINGS

ITEM NAME	PART NUMBER	QUANTITY
CAP,ENG MOUNT DAMPER (Ref # 11012)	11012-1182	2
COVER,ORNAMENT,RH (Ref # 14025)	14025-1375	1
PLATE,IGNITION COIL (Ref # 21048)	21048-1001	2
BRACKET-ENGINE (Ref # 32029)	32029-1142	1
BRACKET-ENGINE,RR,LH (Ref # 32029A)	32029-1163	1
BRACKET-ENGINE,RR,RH (Ref # 32029B)	32029-1164	1
GRIP-FRAME (Ref # 32109)	32109-1021	1
STAY,MUFFLER,LH (Ref # 35011)	35011-1071	1
STAY,MUFFLER,RH (Ref # 35011A)	35011-1072	1
BOLT,HEX HEAD,6MM (Ref # 92001)	92001-137	4
BOLT,FLANGED,8X35 (Ref # 92001A)	92001-1577	6
BOLT-FLANGE (Ref # 92001B)	92001-1582	2
BOLT (Ref # 92001C)	92001-1585	1
BOLT,FLANGED,10X320,B (Ref # 92001D)	92001-1624	1
BOLT,FLANGED,12X320 (Ref # 92001E)	92001-1594	1
NUT,10MM (Ref # 92015)	92015-1429	2
NUT-LOCK,12MM (Ref # 92015A)	92019-009	1
WASHER,PLAIN (Ref # 92022)	92022-1022	2
WASHER,U FORMED (Ref # 92022A)	92022-1259	1
COLLAR,13X25X39.5 (Ref # 92027)	92027-1329	1
PLUG,FRAME END (Ref # 92066)	92066-1034	1
DAMPER,ENG MOUNT,RR,I (Ref # 92075)	92075-1330	2
DAMPER,ENG MOUNT,RR,S (Ref # 92075A)	92075-1331	2
BOLT-SMALL-FINE,10X45 (Ref # 113)	113G1045	4
BOLT-SMALL-UPSET,8X16 (Ref # 114)	115G0816	2
SCREW-PAN-CROS, 6X14 (Ref # 220)	220C0614	2
NUT,8M/M (Ref # 317)	317B0800	2
WASHER PLAIN 8MM (Ref # 410)	410B0800	2
WASHER PLAIN (Ref # 411)	411F0600	2

1983 Shaft PARTS LIST

FRAME FITTINGS

ITEM NAME	PART NUMBER	QUANTITY
WASHER SPRING 8MM (Ref # 461)	461F0800	4
WASHER SPRING 10MM (Ref # 461A)	461F1000	4