

1983 Shaft PARTS DIAGRAM

HANDLEBAR (KZ1100-A1/A2)

F2310-0202

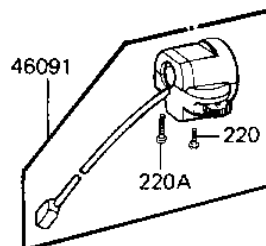
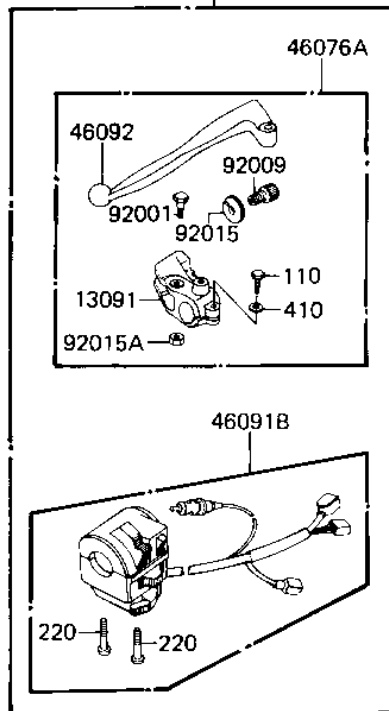
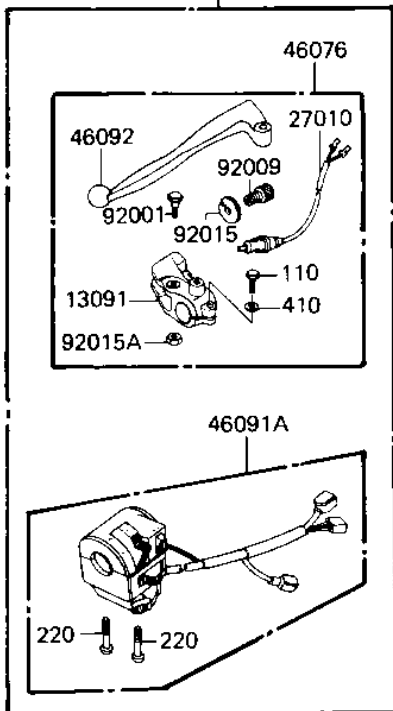
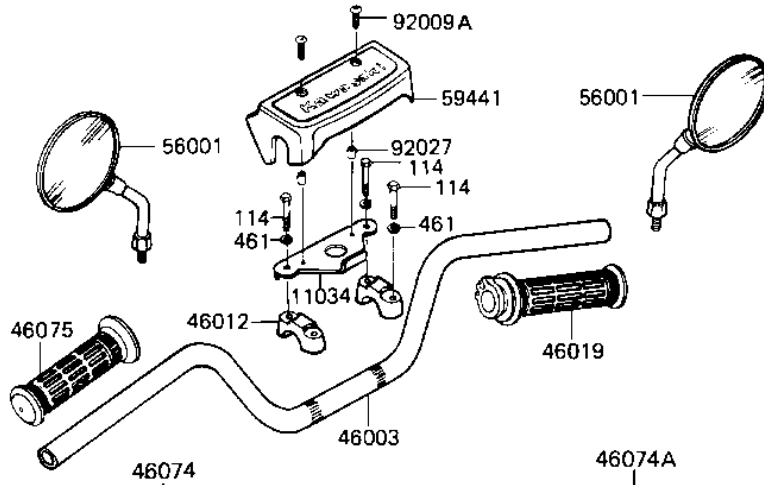

1983 Shaft PARTS LIST

HANDLEBAR (KZ1100-A1/A2)

ITEM NAME	PART NUMBER	QUANTITY
BRACKET,HANDLE COVER (Ref # 11034)	11034-1899	1
HOLDER,CLUTCH LEVER (Ref # 13091)	13091-1046	1
SWITCH,CLUTCH (Ref # 27010)	27010-1045	1
HANDLEBAR (Ref # 46003)	46003-1076	1
HOLDER-HANDLE (Ref # 46012)	46012-1011	2
GRIP-ASSY,THROTTLE (Ref # 46019)	46019-1015	1
GRIP,LH (Ref # 46075)	46075-1022	1
LEVER-ASSY-GRIP,LH (Ref # 46076)	46076-1017	1
LEVER-ASSY-GRIP,CLTCH (Ref # 46076A)	46076-1019	1
HOUSING-ASSY-CNTRL,RH (Ref # 46091)	46091-1155	1
HOUSING-ASSY-CNTRL,LH (Ref # 46091A)	46091-1183	1
HOUSING-ASSY-CNTRL,LH (Ref # 46091B)	46091-1183	1
LEVER,CLUTCH (Ref # 46092)	46092-1005	1
MIRROR-ASSY (Ref # 56001)	56001-1346	2
COVER-HANDLE (Ref # 59441)	59441-1003	1
BOLT,CLUTCH LEVER FIT (Ref # 92001)	92001-1075	1
SCREW CABLE ADJUST (Ref # 92009)	46055-003	1
SCREW,4X16 (Ref # 92009A)	92009-1108	2
NUT-LOCK (Ref # 92015)	46056-005	1
NUT (Ref # 92015A)	92019-008	1
COLLAR,4.5X6.5X9.3 (Ref # 92027)	92027-1313	2
BOLT, HEX HEAD 6X22 (Ref # 110)	110N0622	1
BOLT,SMALL UPSET (Ref # 114)	115G0835	4
SCREW-PAN-CROS (Ref # 220)	220B0535	3
SCREW-PAN-CROS (Ref # 220A)	220B0540	1
WASHER PLAIN 6MM (Ref # 410)	410B0600	1
WASHER SPRING 8MM (Ref # 461)	461F0800	4