

1982 GPz PARTS DIAGRAM

HEADLIGHT (KZ1100-B1)

F2710-0038

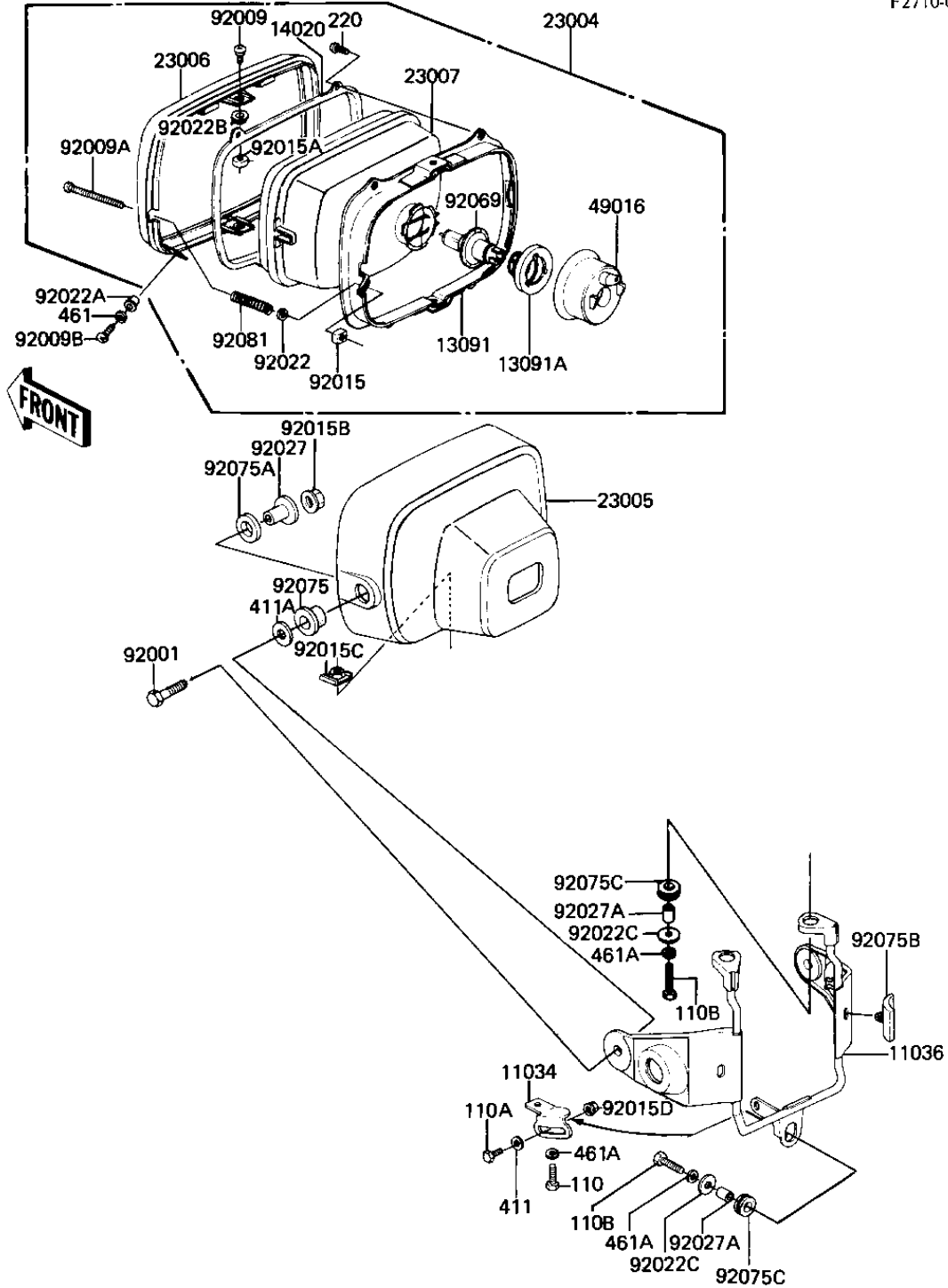

1982 GPz PARTS LIST

HEADLIGHT (KZ1100-B1)

ITEM NAME	PART NUMBER	QUANTITY
BRACKET,HEAD LAMP (Ref # 11034)	11034-1937	1
BRACKET-A,HEAD LAMP (Ref # 11036)	11036-1059	1
HOLDER,HEAD LAMP MOUN (Ref # 13091)	13091-1035	1
HOLDER,HEAD LAMP SOCK (Ref # 13091A)	13091-1036	1
RETAINER,HEAD LAMP (Ref # 14020)	14020-1005	1
LAMP-HEAD (Ref # 23004)	23004-1075	1
BODY-COMP-HEAD LAMP,F (Ref # 23005)	23005-1024-21	1
RIM,HEAD LAMP (Ref # 23006)	23006-1005	1
LENS UNIT,HEAD LAMP (Ref # 23007)	23007-1013	1
COVER,HEAD LAMP SOCKE (Ref # 49016)	49016-1023	1
BOLT 8X38 (Ref # 92001)	92001-1405	2
SCREW-PAN HEAD,5X12 (Ref # 92009)	23019-023	2
SCREW,HEAD LAMP LENS (Ref # 92009A)	92009-1047	1
SCREW-PAN HEAD,5MM (Ref # 92009B)	92011-024	2
NUT,4MM (Ref # 92015)	23020-018	1
NUT,HEAD LAMP RIM FIT (Ref # 92015A)	23020-023	1
NUT,8M/M (Ref # 92015B)	92015-1014	2
NUT,HEAD LAMP BODY FT (Ref # 92015C)	92015-1050	1
NUT-6MM (Ref # 92015D)	92015-1078	1
WASHER (Ref # 92022)	23021-004	1
WASHER (Ref # 92022A)	23021-010	2
WASHER-PLAIN,5MM (Ref # 92022B)	23021-012	2
WASHER 6.5X20X1.6T (Ref # 92022C)	92022-125	3
COLLAR,HEAD LAMP FITT (Ref # 92027)	92027-1131	2
COLLAR,REAR FENDER (Ref # 92027A)	92027-162	3
BULB,12V-60/55W (Ref # 92069)	92069-1002	1
DAMPER,HEAD LAMP FITT (Ref # 92075)	92075-1109	2
DAMPER,HEAD LAMP FITT (Ref # 92075A)	92075-1110	2
DAMPER RUBBER (Ref # 92075B)	92075-1243	2

1982 GPz PARTS LIST

HEADLIGHT (KZ1100-B1)

ITEM NAME	PART NUMBER	QUANTITY
DAMPER RUBBER,RR FENR (Ref # 92075C)	92075-209	3
SPRING,HEAD LAMP LENS (Ref # 92081)	92081-1103	1
BOLT-UPSET,6X12 (Ref # 110)	112G0612	1
BOLT-UPSET 6X14 (Ref # 110A)	112B0614	1
BOLT-UPSET (Ref # 110B)	112G0625	3
SCREW PAN HEAD 3X8 (Ref # 220)	220B0308	4
WASHER PLAIN 6MM (Ref # 411)	411B0600	1
WASHER,PLAIN,8MM (Ref # 411A)	411D0800	2
WASHER SPRING 5MM (Ref # 461)	461F0500	2
WASHER SPRING 6MM (Ref # 461A)	461F0600	4