

1983 KDX80 PARTS DIAGRAM

KICKSTARTER MECHANISM (KDX80-B3)

E1340-0033

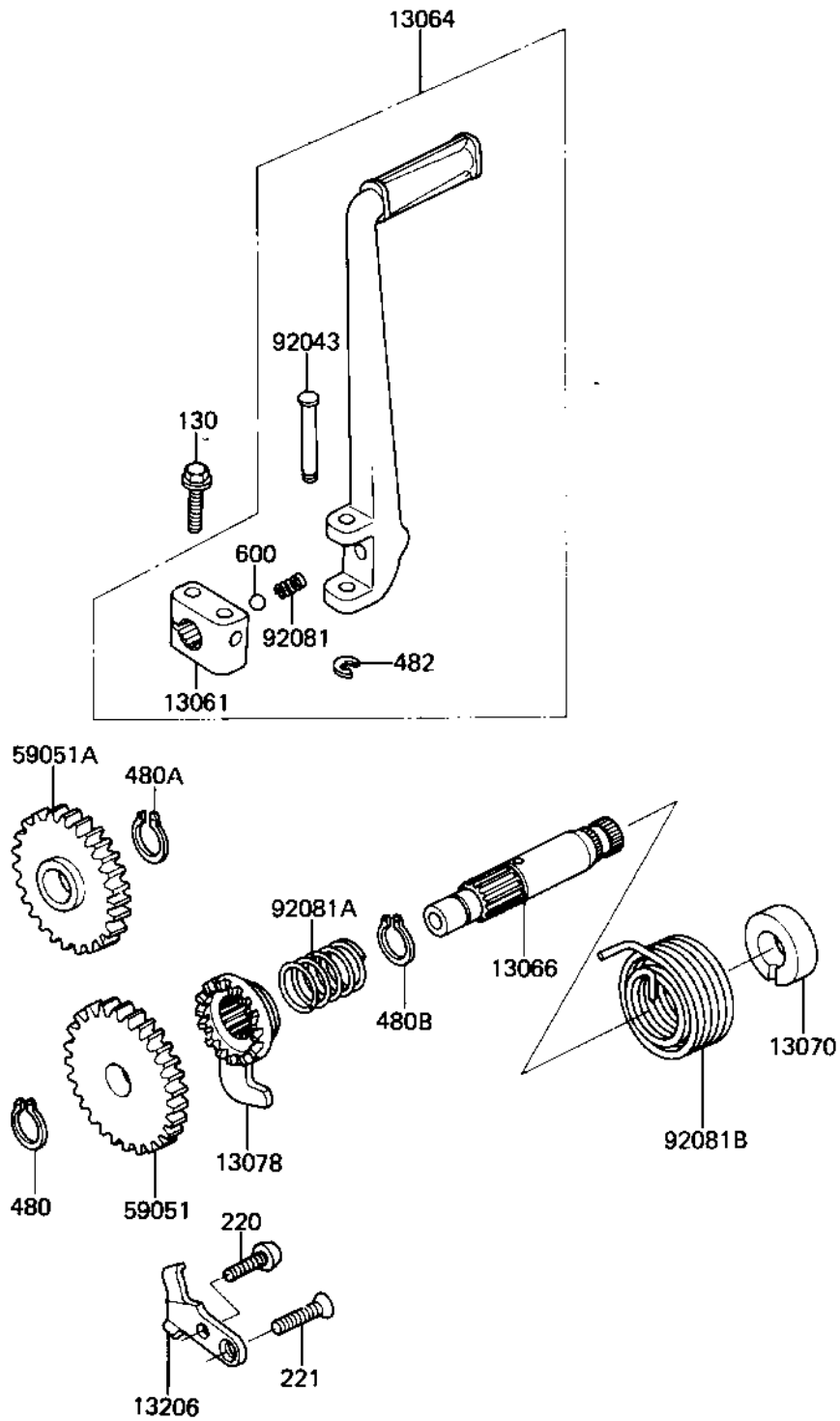

1983 KDX80 PARTS LIST

KICKSTARTER MECHANISM (KDX80-B3)

ITEM NAME	PART NUMBER	QUANTITY
BOSS,KICK PEDAL (Ref # 13061)	13061-1053	1
LEVER-ASSY-KICK,PEDAL (Ref # 13064)	13064-1045	1
SHAFT-KICK (Ref # 13066)	13066-1027	1
GUIDE,KICK SPRING (Ref # 13070)	13070-1034	1
RATCHET (Ref # 13078)	13078-1004	1
GUIDE-KICK,RATCHET (Ref # 13206)	13206-1008	1
GEAR,KICK,32T (Ref # 59051)	59051-1026	1
GEAR,IDLE,30T (Ref # 59051A)	59051-1027	1
PIN,KICK PEDAL (Ref # 92043)	92043-1050	1
SPRING KICK PEDAL (Ref # 92081)	92081-020	1
SPRING,RATCHET (Ref # 92081A)	92081-122	1
SPRING,KICK (Ref # 92081B)	92081-1434	1
BOLT-FLANGED,6X20 (Ref # 130)	130P0620	1
SCREW PAN HEAD 6X16 (Ref # 220)	220B0616	1
SCREW 6X18 (Ref # 221)	221B0618	1
CIRCLIP 12MM (Ref # 480)	480J1200	1
CIRCLIP 15MM (Ref # 480A)	480J1500	1
CIRCLIP 16MM (Ref # 480B)	480J1600	1
CIRCLIP 5MM (Ref # 482)	482K5000	1
BALL STEEL 1/4' (Ref # 600)	600A0800	1