

1979 KZ650-B3 PARTS DIAGRAM

FENDERS

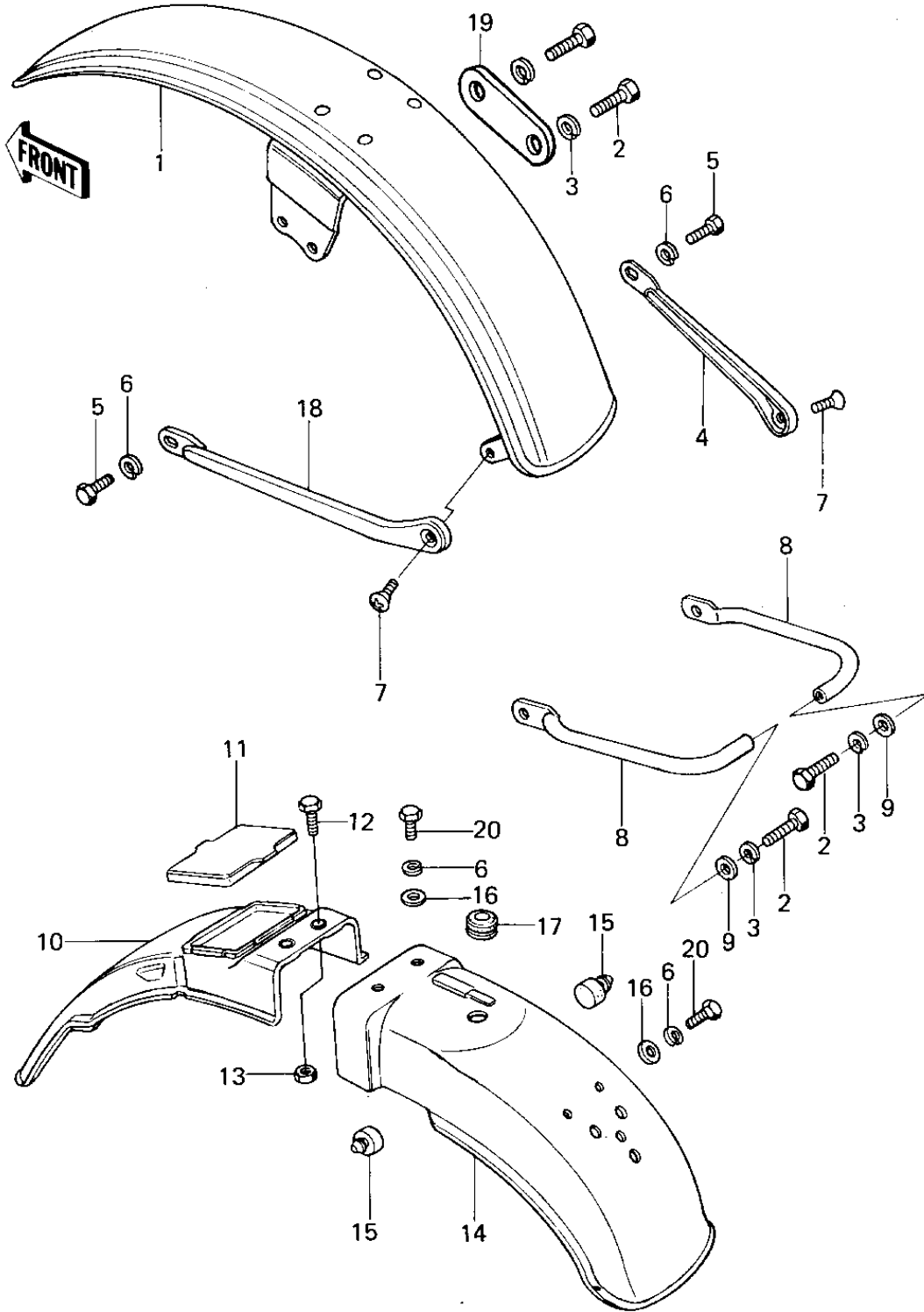

1979 KZ650-B3 PARTS LIST

FENDERS

ITEM NAME	PART NUMBER	QUANTITY
FENDER-FR (Ref # 1)	35001-1017	1
BOLT-SMALL-UPSET,8X16 (Ref # 2)	115G0816	6
WASHER SPRING 8MM (Ref # 3)	461F0800	6
STAY,FRONT FENDER (Ref # 4)	35010-030	1
BOLT-UPSET,6X12 (Ref # 5)	112G0612	2
WASHER SPRING 6MM (Ref # 6)	461F0600	6
SCREW,OVL CNTSNK,6X16 (Ref # 7)	222E0616	2
GRIP,FRAME (Ref # 8)	32109-016	2
WASHER PLAIN 8MM (Ref # 9)	410B0800	2
FENDER-RR (Ref # 10)	35022-1046	1
FENDER-RR (Ref # 10)	35022-1046	1
CASE,MANUAL (Ref # 11)	32099-019	1
BOLT-UPSET,6X16 (Ref # 12)	112G0616	2
NUT,LOCK 6MM (Ref # 13)	92017-014	2
FENDER-RR (Ref # 14)	35022-153	1
DAMPER RUBBER,RR FEND (Ref # 15)	92075-135	2
WASHER PLAIN 6MM (Ref # 16)	410B0600	4
GROMMET HARNESS 10MM (Ref # 17)	92071-019	1
STAY,FRONT FENDER (Ref # 18)	35010-030	1
STAY,FRONT FENDER,L.H (Ref # 18)	35011-1007	1
SPACER,FRONT FENDER (Ref # 19)	92026-1008	1
BOLT-UPSET 6X14 (Ref # 20)	112B0614	4