

1978 KZ1000 PARTS DIAGRAM

CYLINDER HEAD/COVER ('77-'78 A1/A2/A2A)

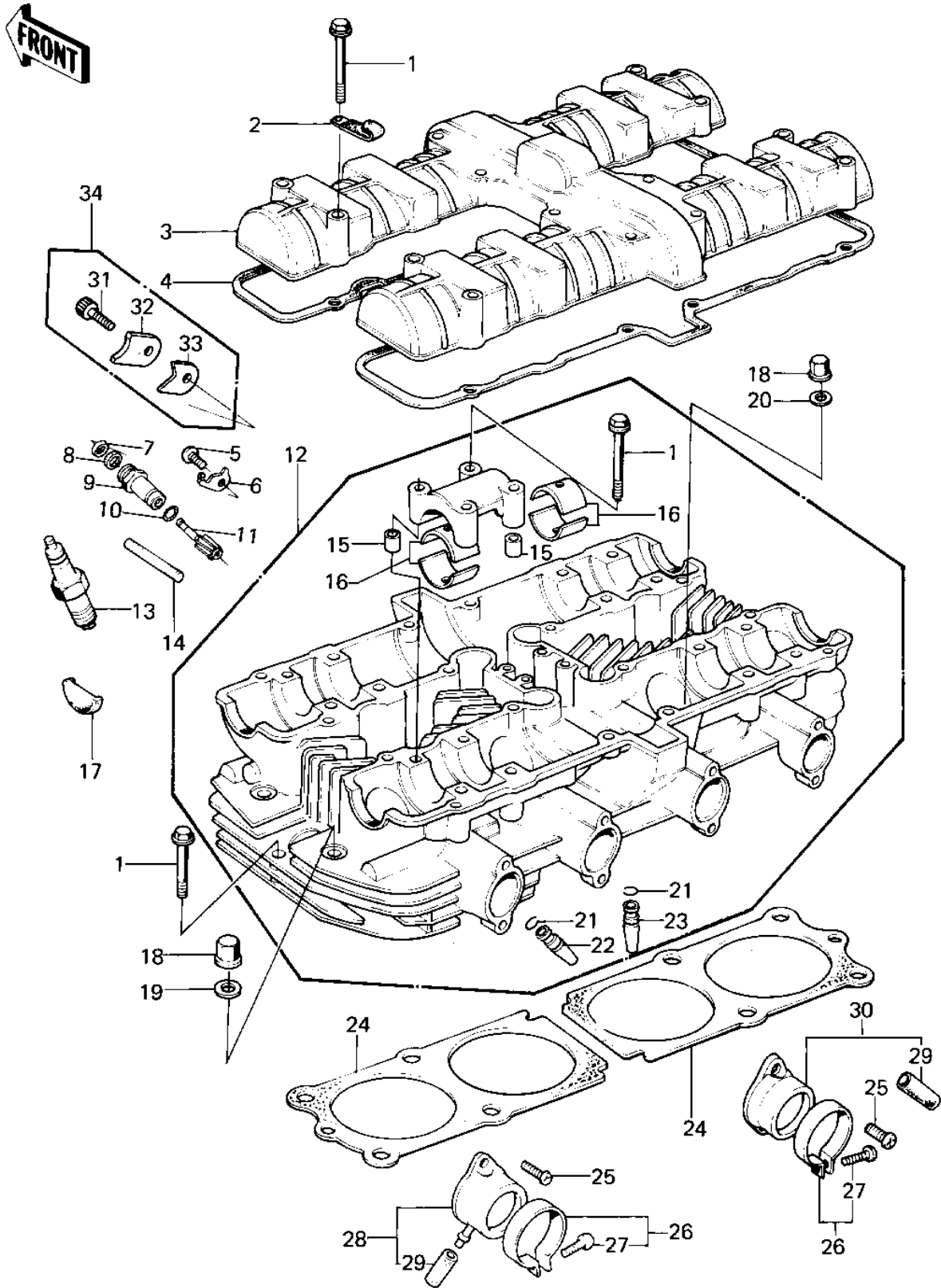

1978 KZ1000 PARTS LIST

CYLINDER HEAD/COVER ('77-'78 A1/A2/A2A)

ITEM NAME	PART NUMBER	QUANTITY
BOLT,HEX HEAD,6X45 (Ref # 1)	92003-092	34
CLAMP,WIRING HARNESS (Ref # 2)	21126-007	2
COVER,CYLINDER HEAD (Ref # 3)	11022-012-2H	1
GASKET,CYL HEAD COVE (Ref # 4)	11023-006	1
SCREW PAN HEAD 6X10 (Ref # 5)	220B0610	1
PLATE,STOPPER (Ref # 6)	13169-015	1
GASKET,TACHOMETER GE (Ref # 7)	92065-103	1
OIL SEAL (Ref # 8)	92050-075	1
GUIDE,TACHOMETER GEA (Ref # 9)	92087-010	1
RING-O,10MM (Ref # 10)	92055-096	1
GEAR,TACHOMETER,10T (Ref # 11)	13223-011	1
CYLINDER HEAD,BARREL (Ref # 12)	11002-024-2H	1
SPARK PLUG B8ES (Ref # 13)	92070-037	4
TUD,8X30 (Ref # 14)	92004-065 S	8
PIN-DOWEL (Ref # 15)	92042-007	8
BUSHING,CAMSHAFT (Ref # 16)	13034-030	16
PLUG,CAM SHAFT (Ref # 17)	92066-017	4
NUT,CYLINDER HEAD (Ref # 18)	92015-076	12
WASHER,PLAIN,10MM (Ref # 19)	92022-215	4
WASHER PLAIN 10MM (Ref # 20)	411B1000	8
CIRCLIP-VALVE (Ref # 21)	92036-023	8
GUIDE,INLET VALVE (Ref # 22)	12013-009	4
GUIDE,EXHAUST VALVE (Ref # 23)	49002-1002	4
GUIDE,EXHAUST VALVE (Ref # 23)	49002-1002	4
GASKET,CYLINDER HEAD (Ref # 24)	11004-076	2
SCREW PAN HEAD 6X18 (Ref # 25)	220B0618	8
CLAMP,HOLDER (Ref # 26)	92123-001	4
SCREW,PAN HEAD (Ref # 27)	92011-037	4
HOLDER,CARBURETOR,L. (Ref # 28)	16065-029	2

1978 KZ1000 PARTS LIST

CYLINDER HEAD/COVER ('77-'78 A1/A2/A2A)

ITEM NAME	PART NUMBER	QUANTITY
RUBBER PLUG (Ref # 29)	92068-006	4
HOLDER-R.H CARBRETOR (Ref # 30)	16065-028	2
BOLT,6X14 (Ref # 31)	120P0614	1
HOLDER,TACHOMETER2.3 (Ref # 32)	13091-1008	1
HOLDER,TACHOMETR,3.2 (Ref # 33)	13091-1009	1
HOLDER SET,TACHOMETE (Ref # 34)	13091-5001	1