

# 1978 KZ1000 PARTS DIAGRAM

TRANSMISSION/CHANGE DRUM ('77-'78 A1/A2/)

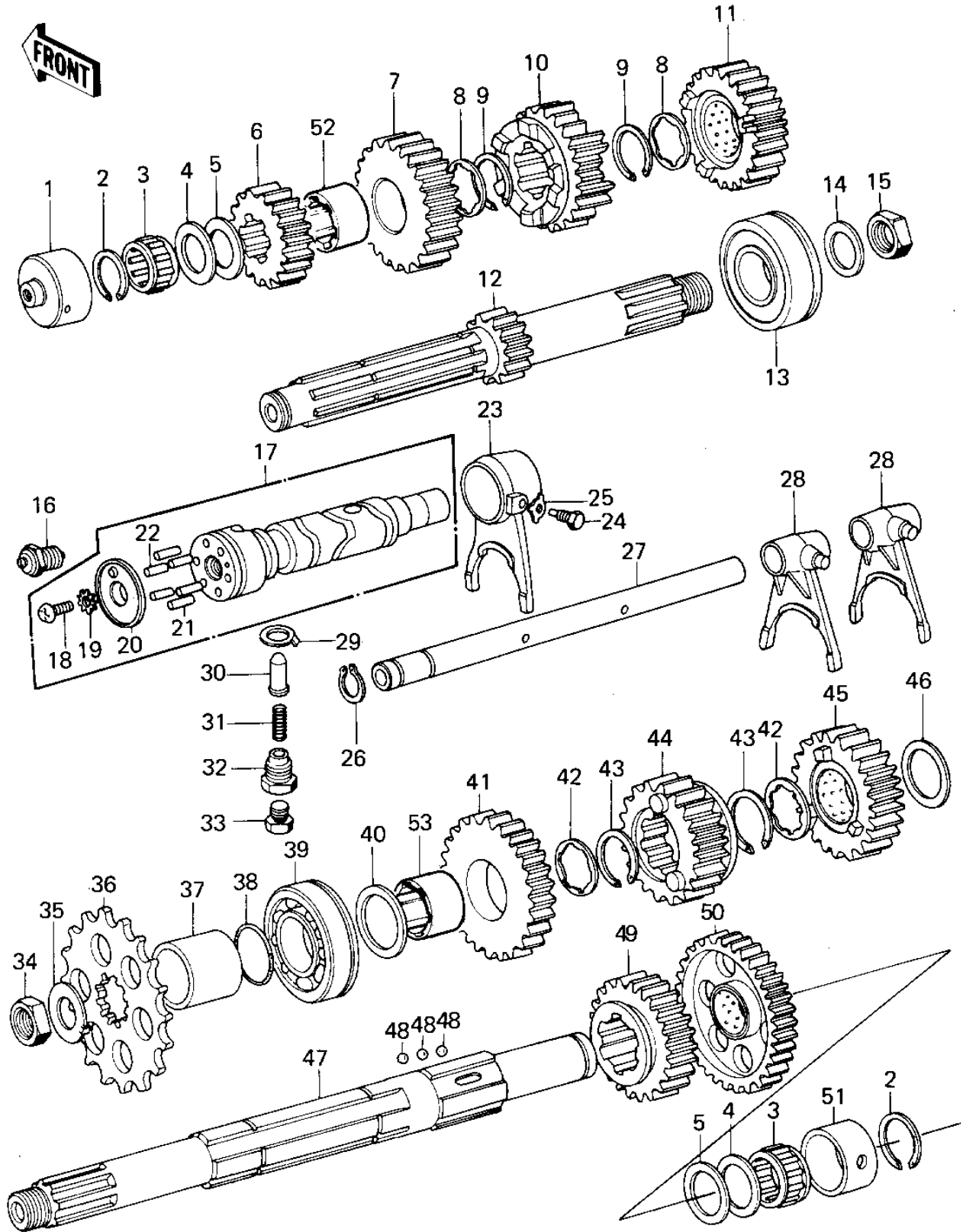

# 1978 KZ1000 PARTS LIST

TRANSMISSION/CHANGE DRUM ('77-'78 A1/A2/

ITEM NAME	PART NUMBER	QUANTITY
BUSH,DRIVE SHAFT (Ref # 1)	92028-122	1
CIRCLIP,25MM (Ref # 2)	92033-025	2
BEARING,PK223013.8 (Ref # 3)	92046-031	2
WASHER,PLAIN,22MM (Ref # 4)	92022-212	2
WASHER,PLAIN,22MM (Ref # 4)	92022-213	2
WASHER, THRUST (Ref # 5)	92022-211	2
2ND GER,DRIVE SHAFT (Ref # 6)	13130-032	1
TOP GEAR,DRIVE SHAFT (Ref # 7)	13136-042	1
WASHER,THRUST,26MM (Ref # 8)	92024-042	2
CIRCLIP 28MM (Ref # 9)	480J2800	2
3RD GEAR,DRIVE SHAFT (Ref # 10)	13132-030	1
4TH GEAR,DRIVE SHAFT (Ref # 11)	13134-016	1
SHAFT,DRIVE 12T (Ref # 12)	13127-042	1
BEARING,BALL,5305NSH (Ref # 13)	92045-022	1
WASHER (Ref # 14)	92125-002	1
NUT,20MM (Ref # 15)	92019-015	1
SWITCH,NEUTRAL (Ref # 16)	13151-022	1
DRUM ASSY,GEAR CHANG (Ref # 17)	13239-1010	1
DRUM ASSY,GEAR CHANG (Ref # 17)	13239-1010	1
SCREW PAN HEAD 6X14 (Ref # 18)	220B0614	1
SCREW CNTSNK HD 6X20 (Ref # 18)	221B0620	1
WASHER LOCK 6MM (Ref # 19)	464G0600	1
PLATE,GEAR CHNG DRUM (Ref # 20)	13142-013	1
HOLDER,CHANGE DRUM (Ref # 20)	13091-1013	1
PIN GEAR CHANGE DRUM (Ref # 21)	92042-014	5
PIN-CHANGE DRUM (Ref # 22)	92042-020	1
FORK,SELECTOR,3RD (Ref # 23)	13140-046	1
PIN SELECT FORK GUID (Ref # 24)	92043-016	1
WASHER LOCK 10MM (Ref # 25)	92031-001	1

# 1978 KZ1000 PARTS LIST

TRANSMISSION/CHANGE DRUM ('77-'78 A1/A2/

ITEM NAME	PART NUMBER	QUANTITY
CIRCLIP 12MM (Ref # 26)	480J1200	1
ROD,SHIFT (Ref # 27)	13209-011	1
FORK,SELECTOR,4TH&TO (Ref # 28)	13140-045	2
WASHER,LOCK (Ref # 29)	92024-047	1
PIN (Ref # 30)	92043-085	1
SPRING (Ref # 31)	92081-106	1
BOLT,CHG DRUM POSITN (Ref # 32)	92001-112	1
BOLT (Ref # 33)	92001-119	1
NUT 20MM (Ref # 34)	92016-028	1
WASHER,LOCK,20MM (Ref # 35)	92024-044	1
ENGINE SPROCKET,15T (Ref # 36)	13144-1001	1
COLLAR,ENG SPROCKET (Ref # 37)	92027-288	1
"O" RING (Ref # 38)	92055-035	1
BEARING,BL305 256217 (Ref # 39)	92045-021	1
WASHER,PLAIN,25MM (Ref # 40)	92022-210	1
2ND GEAR,OUTPUT SHAF (Ref # 41)	13131-038	1
WASHER THRUST,28MM (Ref # 42)	92024-043	2
CIRCLIP,30MM (Ref # 43)	480J3000	2
TOP GEAR,OUTPUT SHAF (Ref # 44)	13137-025	1
3RD GEAR,OUTPUT SHAF (Ref # 45)	13133-031	1
WASHER,PLAIN,30MM (Ref # 46)	92022-209	1
SHAFT,OUTPUT (Ref # 47)	13128-1001	1
SHAFT,OUTPUT (Ref # 47)	13128-1001	1
BALL STEEL 3/16' (Ref # 48)	600A0600	3
4TH GEAR,OUTPUT SHAF (Ref # 49)	13135-020	1
LOW GER,OUTPUT SHAFT (Ref # 50)	13129-046	1
BUSH,OUTPUT SHAFT (Ref # 51)	92028-123	1
BUSHING,TOP GEAR (Ref # 52)	92028-1006	1
BUSHING,2ND GEAR (Ref # 53)	92028-1005	1