

# 1978 KZ1000 PARTS DIAGRAM

BATTERY CASE/TOOL CASE ('77-'78 A1/A2/A2)

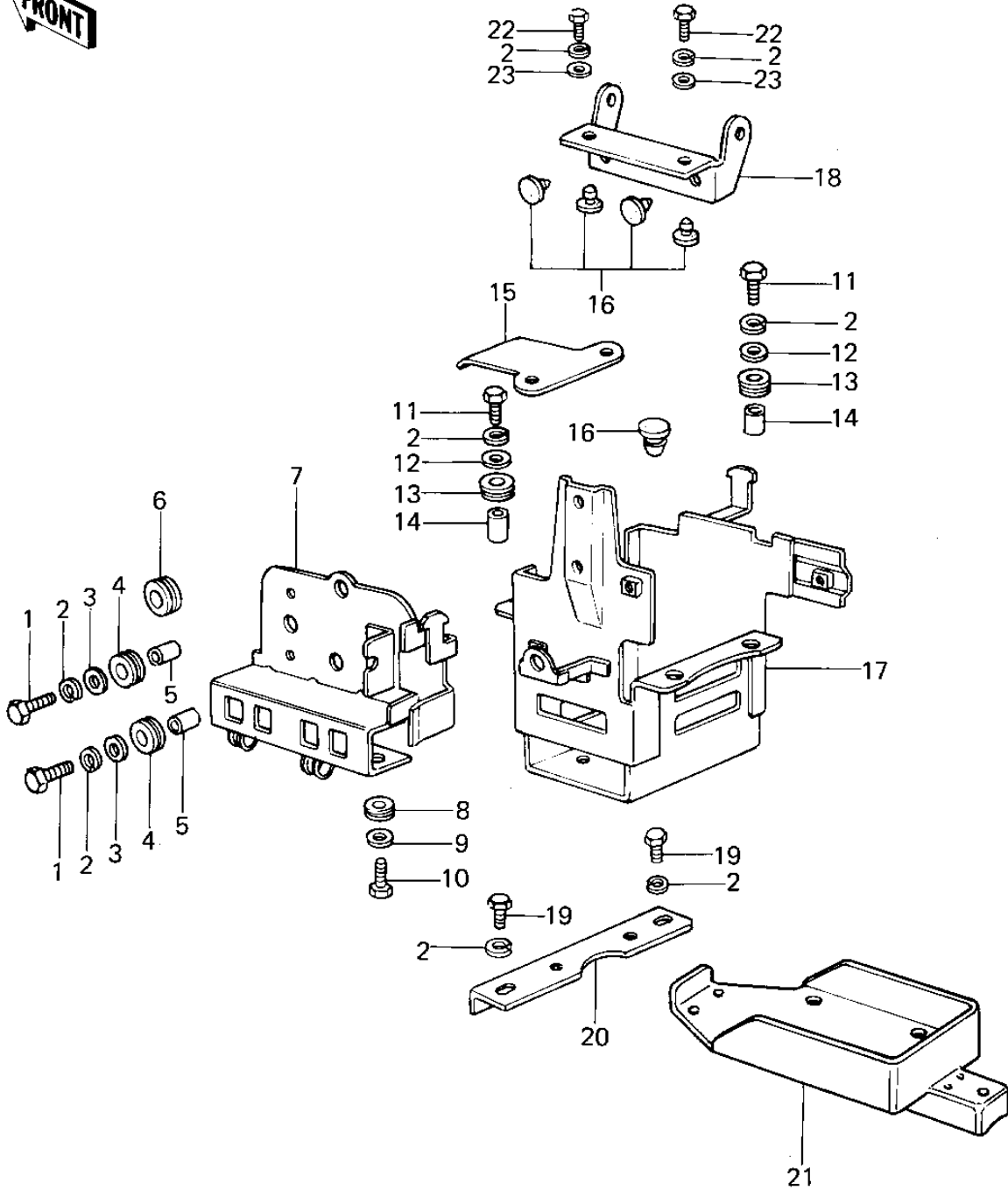

# 1978 KZ1000 PARTS LIST

BATTERY CASE/TOOL CASE ('77-'78 A1/A2/A2)

ITEM NAME	PART NUMBER	QUANTITY
BOLT-UPSET,6X20 (Ref # 1)	112G0620	2
WASHER SPRING 6MM (Ref # 2)	461F0600	10
WASHER 6.5X22X1.6T (Ref # 3)	92022-237	2
DAMPER RUBBER (Ref # 4)	92075-149	2
COLLAR (Ref # 5)	92027-165	2
DAMPER RUBBER (Ref # 6)	92075-051	1
DAMPER RUBBER (Ref # 7)	92075-051	1
DAMPER RUBBER,BATTER (Ref # 8)	92075-161	2
WASHER PLAIN 8MM (Ref # 9)	410B0800	2
BOLT,HEAX HEAD,6X14 (Ref # 10)	92001-115	2
BOLT-UPSET (Ref # 11)	112G0630	4
UNAVAILABLE IN PRICE BOOK (Ref # 12)	92022 116	4
UNAVAILABLE IN PRICE BOOK (Ref # 13)	92075 146	4
UNAVAILABLE IN PRICE BOOK (Ref # 14)	92027 156	4
UNAVAILABLE IN PRICE BOOK (Ref # 15)	32105 007	1
UNAVAILABLE IN PRICE BOOK (Ref # 16)	92075 078	10
UNAVAILABLE IN PRICE BOOK (Ref # 17)	32097 044	1
BOLT-UPSET,6X16 (Ref # 19)	112G0616	2
PLATE (Ref # 20)	32113-004	1
CASE,TOOL (Ref # 21)	32098-1001	1
BOLT-UPSET,6X12 (Ref # 22)	112G0612	2
WASHER PLAIN 6MM (Ref # 23)	411B0600	2