

1979 KZ1000 PARTS DIAGRAM

CAMSHAFTS/VALVES ('79-'80 A3/A3A/A4)

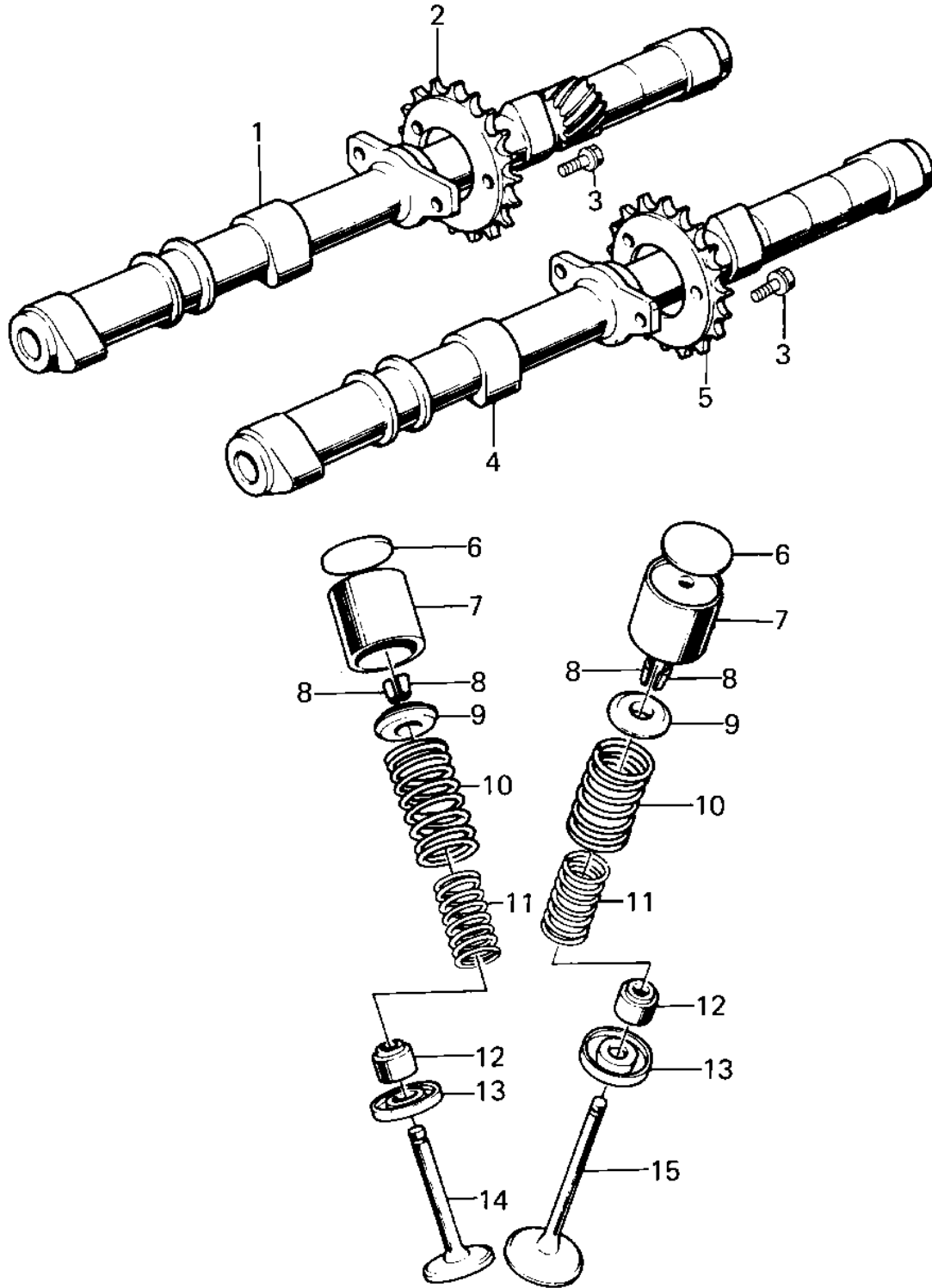

1979 KZ1000 PARTS LIST

CAMSHAFTS/VALVES ('79-'80 A3/A3A/A4)

ITEM NAME	PART NUMBER	QUANTITY
CAMSHAFT,EXHAUST (Ref # 1)	12044-015	1
SPROCKET,EXH CAM SHF (Ref # 2)	12046-1018	1
BOLT,SPROCKET FITTIN (Ref # 3)	92003-208	6
CAMSHAFT,INLET (Ref # 4)	12044-014	1
SPROCKET,INLET CAM S (Ref # 5)	12046-1017	1
SHIM,TAPPET,2.00T (Ref # 6)	12037-001	AR
SHIM,TAPPET,2.05T (Ref # 6)	12037-002	AR
SHIM,TAPPET,2.10T (Ref # 6)	12037-003	AR
SHIM,TAPPET,2.15T (Ref # 6)	12037-004	AR
SHIM,TAPPET,2.20T (Ref # 6)	12037-005	AR
SHIM,TAPPET,2.25T (Ref # 6)	12037-006	AR
SHIM,TAPPET,2.30T (Ref # 6)	12037-007	AR
SHIM,TAPPET,2.35T (Ref # 6)	12037-008	AR
SHIM,TAPPET,2.40T (Ref # 6)	12037-009	AR
SHIM,TAPPET,2.45T (Ref # 6)	12037-010	AR
SHIM,TAPPET,2.50T (Ref # 6)	12037-011	AR
SHIM,TAPPET,2.55T (Ref # 6)	12037-012	AR
SHIM,TAPPET,2.60T (Ref # 6)	12037-013	AR
SHIM,TAPPET,2.65T (Ref # 6)	12037-014	AR
SHIM,TAPPET,2.70T (Ref # 6)	12037-015	AR
SHIM,TAPPET,2.75T (Ref # 6)	12037-016	AR
SHIM,TAPPET,2.80T (Ref # 6)	12037-017	AR
SHIM,TAPPET,2.85T (Ref # 6)	12037-018	AR
SHIM,TAPPET,2.90T (Ref # 6)	12037-019	AR
SHIM,TAPPET,2.95T (Ref # 6)	12037-020	AR
SHIM,TAPPET,3.00T (Ref # 6)	12037-021	AR
SHIM,TAPPET,3.05T (Ref # 6)	12037-022	AR
SHIM,TAPPET,3.10T (Ref # 6)	12037-023	AR
SHIM,TAPPET,3.15T (Ref # 6)	12037-024	AR

1979 KZ1000 PARTS LIST

CAMSHAFTS/VALVES ('79-'80 A3/A3A/A4)

ITEM NAME	PART NUMBER	QUANTITY
SHIM,TAPPET 3.20T (Ref # 6)	12037-025	AR
TAPPET (Ref # 7)	12032-005	8
SPLIT KEEPER (Ref # 8)	12011-004	16
RETAINER,VALVE SPRIN (Ref # 9)	12009-005	8
SPRING,OUTER VALVE (Ref # 10)	12007-012	8
SPRING,INNER VALVE (Ref # 11)	12007-011	8
OIL SEAL,RV37129.5 (Ref # 12)	92049-016	8
SEAT-SPRING,VALVE (Ref # 13)	16007-1024	8
VALVE,EXHAUST (Ref # 14)	12005-1009	4
VALVE,INTAKE (Ref # 15)	12004-1010	4