

1980 KZ1000 PARTS DIAGRAM

CARBURETOR PARTS(CANADA)(79-'80 A3/A3A/

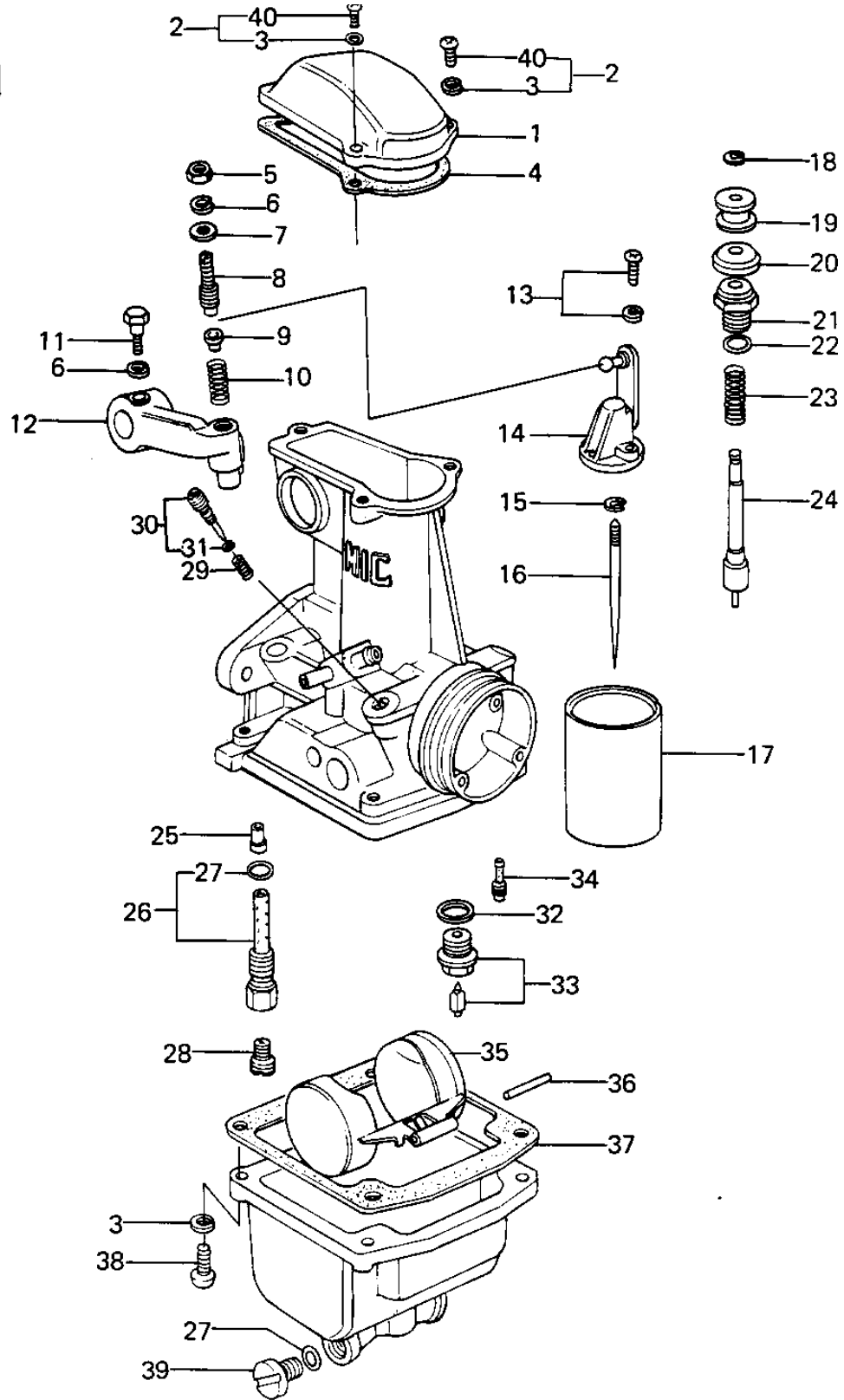

1980 KZ1000 PARTS LIST

CARBURETOR PARTS(CANADA)(79-'80 A3/A3A/

ITEM NAME	PART NUMBER	QUANTITY
TOP,MIXING CHAMBER (Ref # 1)	16005-027	4
SCREW-PAN-WS-CROS (Ref # 2)	223B0414	12
WASHER SPRING 4MM (Ref # 3)	461F0400	28
GASKET,CHAMBER TOP (Ref # 4)	16019-031	4
NUT,5MM (Ref # 5)	16003-013	4
NUT 5MM (Ref # 5)	312B0500	AL
WASHER SPRING 5MM (Ref # 6)	461F0500	8
WASHER,PLAIN (Ref # 7)	16039-016	4
SCREW,SLOTTED (Ref # 8)	16046-012	4
SEAT,SPRING (Ref # 9)	16057-002	4
SPRING (Ref # 10)	16040-026	4
BOLT,HEX HEAD,5X14 (Ref # 11)	16067-006	4
LEVER,THROTTLE (Ref # 12)	39075-1001	4
SCREW,PAN HEAD,3X14 (Ref # 13)	16033-031	8
BRACKET,THROTTLE VAL (Ref # 14)	16007-028	4
CIRCLIP (Ref # 15)	16008-010	4
JET NEEDLE,5CN15 (Ref # 16)	16009-1013	4
VALVE,THROTTLE,CA1.75 (Canada) (Ref # 17)	16025-1033	4
CIRCLIP (Ref # 18)	16076-003	4
COLLAR (Ref # 19)	16073-014	4
CAP,STARTER PLUNGER (Ref # 20)	16039-015	4
CAP,STARTER PLUNGER (Ref # 21)	16012-015	4
"O" RING,9MM (Ref # 22)	670B1509	4
SPRING,STARTER PLUG (Ref # 23)	16013-008	4
PLUNGER,STARTER (Ref # 24)	16016-021	4
NEEDLE JET,O-1 (Ref # 25)	16017-1011	4
*** N.L.A.*** (Canada) (Ref # 26)	49122-1008	4
"O" RING,MAIN JET CO (Ref # 27)	16038-016	8
MAIN JET,#A105R (Ref # 28)	92063-1042	4

1980 KZ1000 PARTS LIST

CARBURETOR PARTS(CANADA)(79-'80 A3/A3A/

ITEM NAME	PART NUMBER	QUANTITY
MAIN JET,#A100 (Ref # 28)	92063-1033	4
MAIN JET,#A102.5 (Ref # 28)	92063-1028	4
JET-MAIN NO 107.5R (Ref # 28)	92063-073	4
MAIN JET,#110R (Ref # 28)	92063-1038	4
SPRING-THR STOP SCRE (Ref # 29)	16022-007	4
SCREW,PILOT ADJUSTIN (Ref # 30)	16014-1004	4
"O" RING (Ref # 31)	16038-022	4
WASHER FLOAT VLV SEA (Ref # 32)	16029-004	4
FLOAT VALVE ASSY (Ref # 33)	16030-027	4
JET-PILOT NO.15 (Ref # 34)	92064-1003	4
FLOAT (Ref # 35)	16031-031	4
GASKET,FLOAT CHAMBER (Ref # 37)	11009-1563	4
SCREW PAN HEAD 4X16 (Ref # 38)	220B0416	16
SCREW,GUIDE (Ref # 39)	16049-007	4
SCREW-PAN-CROS (Ref # 40)	220B0414	12