

1980 KZ1000 PARTS DIAGRAM

FRONT FORK (79-'80 A3/A3A/A4)

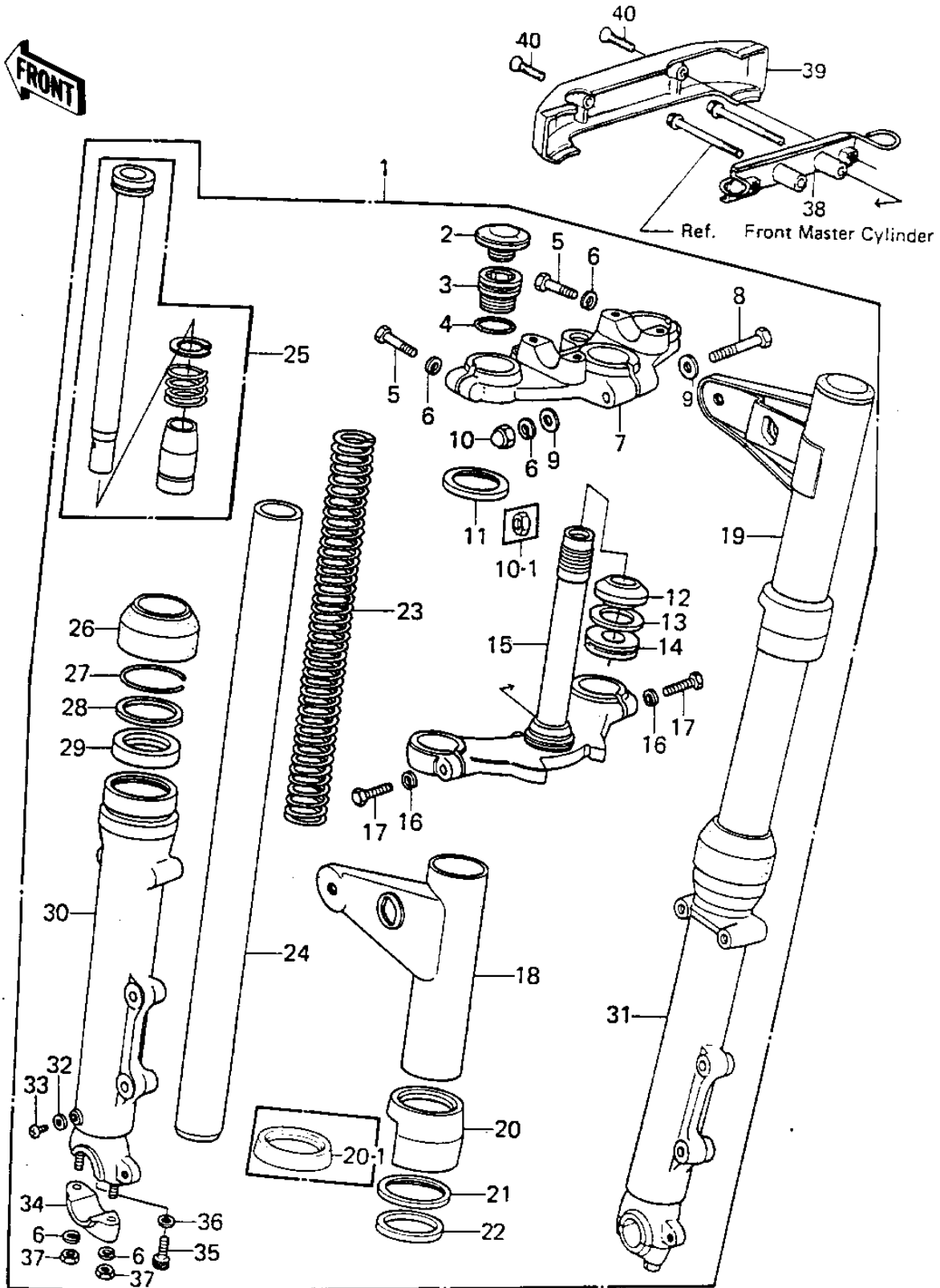

1980 KZ1000 PARTS LIST

FRONT FORK ('79-'80 A3/A3A/A4)

ITEM NAME	PART NUMBER	QUANTITY
FORK-FRONT (Ref # 1)	44001-1040	1
FORK-FRONT (Ref # 1)	44001-1233	1
CAP,RUBBER (Ref # 2)	11012-1017	2
CAP,FORK SPRING (Ref # 3)	44029-1003	2
"O" RING,FORK TOP (Ref # 4)	92055-1009	2
BOLT-HEX HEAD.8M/M (Ref # 5)	44041-045	2
WASHER SPRING 8MM (Ref # 6)	461F0800	7
HEAD,STEERING (Ref # 7)	44039-073	1
BOLT-STEERING STEM H (Ref # 8)	44041-042	1
BOLT-HEX HEAD,8X55 (Ref # 8)	44041-038	1
WASHER PLAIN 8MM (Ref # 9)	410B0800	2
NUT FUEL TANK FRONT (Ref # 10)	92020-007	1
NUT,LOCK,8MM (Ref # 10-1)	92015-1124	1
WASHER,FORK COVER (Ref # 11)	44064-005	2
CONE,STEERING STEM (Ref # 12)	92047-012	1
WASHER,PLAIN (Ref # 13)	92022-231	1
OIL SEAL,STEERING ST (Ref # 14)	92056-003	1
STEM,STEERING (Ref # 12-15)	44037-1015	1
WASHER SPRING 12MM (Ref # 16)	461F1200	2
BOLT-HEX HEAD,12X36 (Ref # 17)	92003-064	2
COVER,L.H,FORK,F.BLA (Ref # 18)	44033-1021	1
COVER,R.H,FORK,F.BLA (Ref # 19)	44033-1022	1
GUIDE,FORK COVER (Ref # 20)	44064-025	2
GUIDE,FORK COVER (Ref # 20-1)	13169-1249	2
WASHER,FORK COU GUID (Ref # 21)	44064-008	2
GASKET,FORK COVER (Ref # 22)	44045-038	2
SPRING,FORK (Ref # 23)	44026-1026	2
TUBE,FORK INNER (Ref # 24)	44013-1003	2
CYLINDER-FORK (Ref # 25)	44022-1011	2

1980 KZ1000 PARTS LIST

FRONT FORK ('79-'80 A3/A3A/A4)

ITEM NAME	PART NUMBER	QUANTITY
DUST SHEILD,FORK (Ref # 26)	44010-032	2
CIRCLIP-OIL SEAL FIT (Ref # 27)	44044-012	2
WASHER-OIL SEAL FIT (Ref # 28)	44043-044	2
OIL SEAL,FORK (Ref # 29)	44009-024	2
TUBE,LH,FORK OUTER (Ref # 30)	44005-1033	1
TUBE,RH,FORK OUTER (Ref # 31)	44006-1033	1
GASKET FORK DRAIN PL (Ref # 32)	44045-002	2
SCREW PAN HEAD 4X8 (Ref # 33)	220B0408	2
HOLDER,FRONT AXLE (Ref # 34)	44063-1004	2
BOLT-FORK CYLINDER (Ref # 35)	44041-040	2
GASKET,FORK CYLINDER (Ref # 36)	44045-057	2
NUT,LOCK,8MM (Ref # 37)	92015-1124	4
BRACKET,FORK COVER (Ref # 38)	11034-1766	1
COVER,FORK (Ref # 39)	44033-1053	1
SCREW-CSK-RD-CROS (Ref # 40)	222C0518	2