

1980 KZ1300-A2 PARTS DIAGRAM

SECONDARY SHAFT

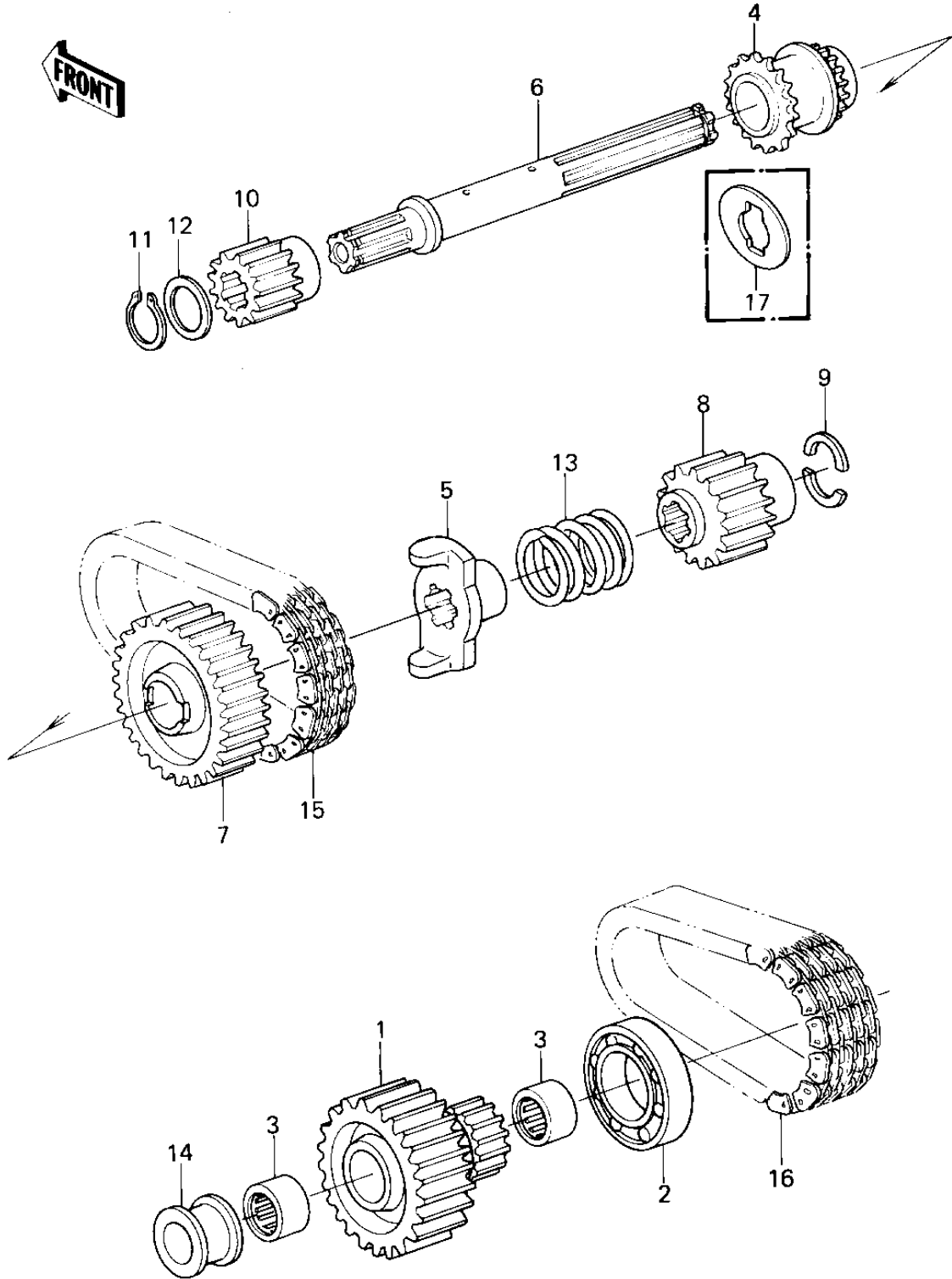

1980 KZ1300-A2 PARTS LIST

SECONDARY SHAFT

ITEM NAME	PART NUMBER	QUANTITY
SPROCKET,SECOND,DRVN (Ref # 1)	13112-1003	3
BEARING,BALL,#6009 (Ref # 2)	92045-1015	3
BEARING,NEEDLE,HK2520 (Ref # 3)	92046-1014	3
SPROCKET,TIMING,28,24 (Ref # 4)	12046-1011	3
FOLLOWER,CAM (Ref # 5)	13048-1001	3
SHAFT,SECONDARY (Ref # 6)	13107-1007	3
SPROCKET,PRIMARY,DRVN (Ref # 7)	13112-1001	3
SPROCKET-PRIMARY,32T (Ref # 7)	13112-1007	3
SPROCKET,SECOND,DRIVE (Ref # 8)	13112-1002	3
RING,POSITON (Ref # 9)	14013-1001	3
GEAR,OIL PUMP DRIVE (Ref # 10)	16085-1004	3
CIRCLIP,25M/M (Ref # 11)	480J2500	3
WASHER,25.3X33X1.0 (Ref # 12)	92022-1109	3
SPRING,CAM FOLLOWER (Ref # 13)	92081-1085	3
COLLAR,25X40X26.1 (Ref # 14)	92027-1136	3
CHAIN,PRIMARY (Ref # 15)	92057-1016	3
CHAIN,SECONDARY (Ref # 16)	92057-1017	3
PLATE,25X54X1.2 (Ref # 17)	13169-1327	3