

1981 KZ1300-A3 PARTS DIAGRAM

CRANKCASE

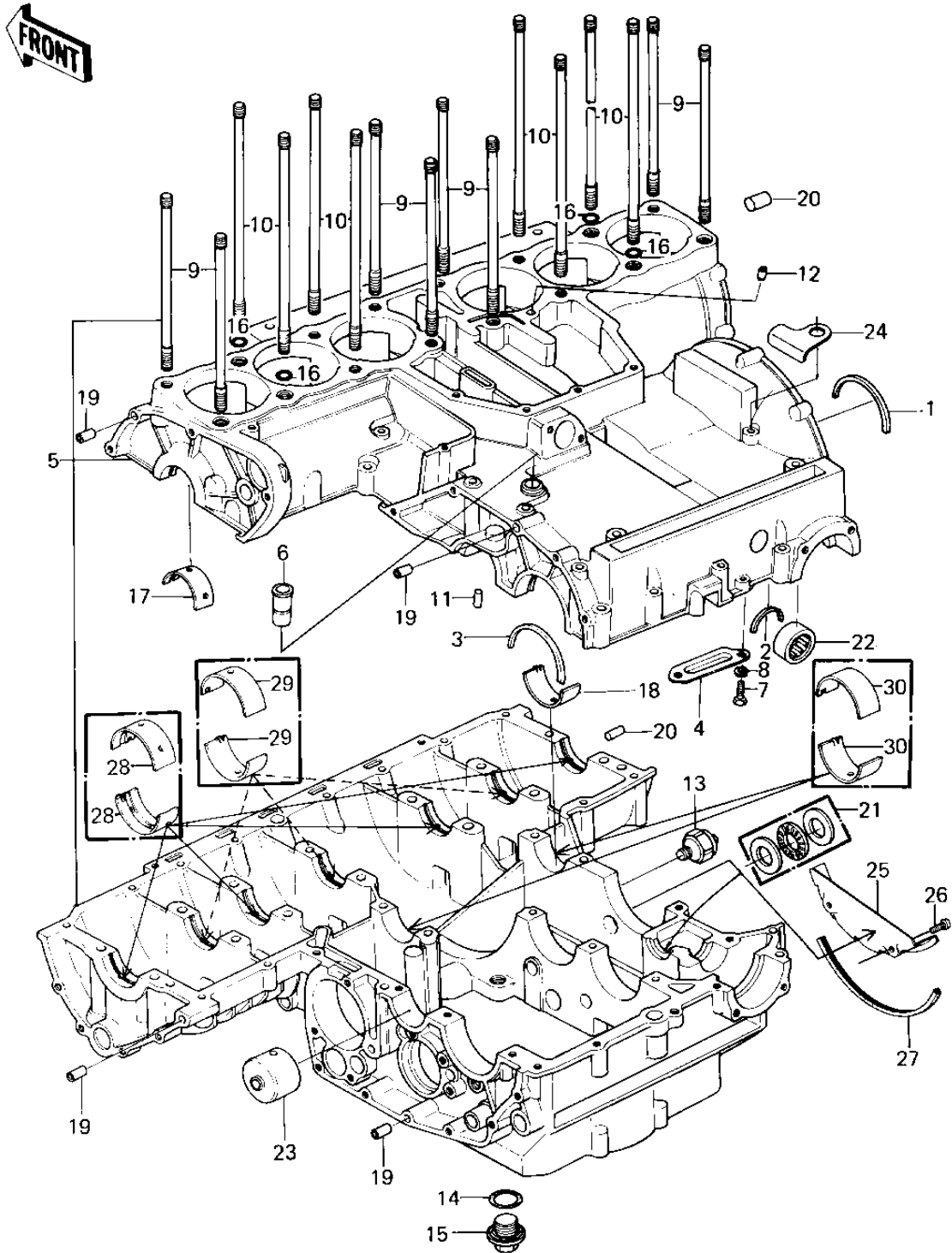

1981 KZ1300-A3 PARTS LIST

CRANKCASE

ITEM NAME	PART NUMBER	QUANTITY
RING-BEARING SET (Ref # 1)	14013-013	AR
RING,POSITION (Ref # 1)	14013-1004	AR
RING,POSITION (Ref # 2)	14013-1002	1
RING,POSITION (Ref # 3)	14013-1004	1
RECEIVER,OIL (Ref # 4)	13045-1002	1
CRANKCASE SET (Ref # 5)	14001-5058	1
CRANKCASE SET (Ref # 5)	14001-5058	1
CRANKCASE SET (Ref # 5)	14001-5058	1
SET-CRANKCASE,SILVER (Ref # 5)	14001-5066	1
.BREATHER JOINT (Ref # 6)	14067-006	1
BOLT-UPSET,6X16 (Ref # 7)	112G0616	2
WASHER SPRING 6MM (Ref # 8)	461F0600	2
.STUD,10X153 (Ref # 9)	92004-062	8
.STUD,10X195 (Ref # 10)	92004-1019	8
.PIN DOWEL 6MM (Ref # 11)	92042-016	1
.NOZZLE,OIL BIAS (Ref # 12)	92062-011	1
SWITCH ASY,OIL PRSSUR (Ref # 13)	16144-006	1
"O" RING,22MM (Ref # 14)	670B2022	1
PLUG,OIL DRAIN (Ref # 15)	92001-1183	1
."O" RING,12MM (Ref # 16)	670B2012	4
BUSHING,MAIN JOURNAL (Ref # 17)	92028-1105	8
BUSHING,MAIN JOURNAL (Ref # 18)	92028-1108	10
PIN-DOWEL (Ref # 19)	92042-007	4
PIN DOWEL 6MM (Ref # 20)	92042-016	2
BEARING,N,NTBGW1528 (Ref # 21)	92046-1017	1
BEARING,N,TR-22301302 (Ref # 22)	92046-1018	1
RACE,DRIVE SHAFT,L.H: (Ref # 23)	92048-1008	1
CLAMP,CABLE (Ref # 24)	92037-1152	1
BAFFLE (Ref # 25)	18020-1022	1

1981 KZ1300-A3 PARTS LIST

CRANKCASE

ITEM NAME	PART NUMBER	QUANTITY
SCREW PAN HEAD 6X10 (Ref # 26)	220B0610	2
SEAL (Ref # 27)	92093-1040	1
BUSHING,MAIN JOURNAL (Ref # 28)	92028-1103	AR
BUSHING,MAIN JOURNAL (Ref # 28)	92028-1104	AR
BUSHING,MAIN JOURNAL (Ref # 28)	92028-1105	AR
BUSHING,MAIN JOURNAL (Ref # 29)	92028-1106	AR
BUSHING,MAIN JOURNAL (Ref # 29)	92028-1107	AR
BUSHING,MAIN JOURNAL (Ref # 29)	92028-1108	AR
BUSHING,MAIN JOURNAL (Ref # 30)	92028-1108	4