

1981 KZ1300-A3 PARTS DIAGRAM

TRANSMISSION

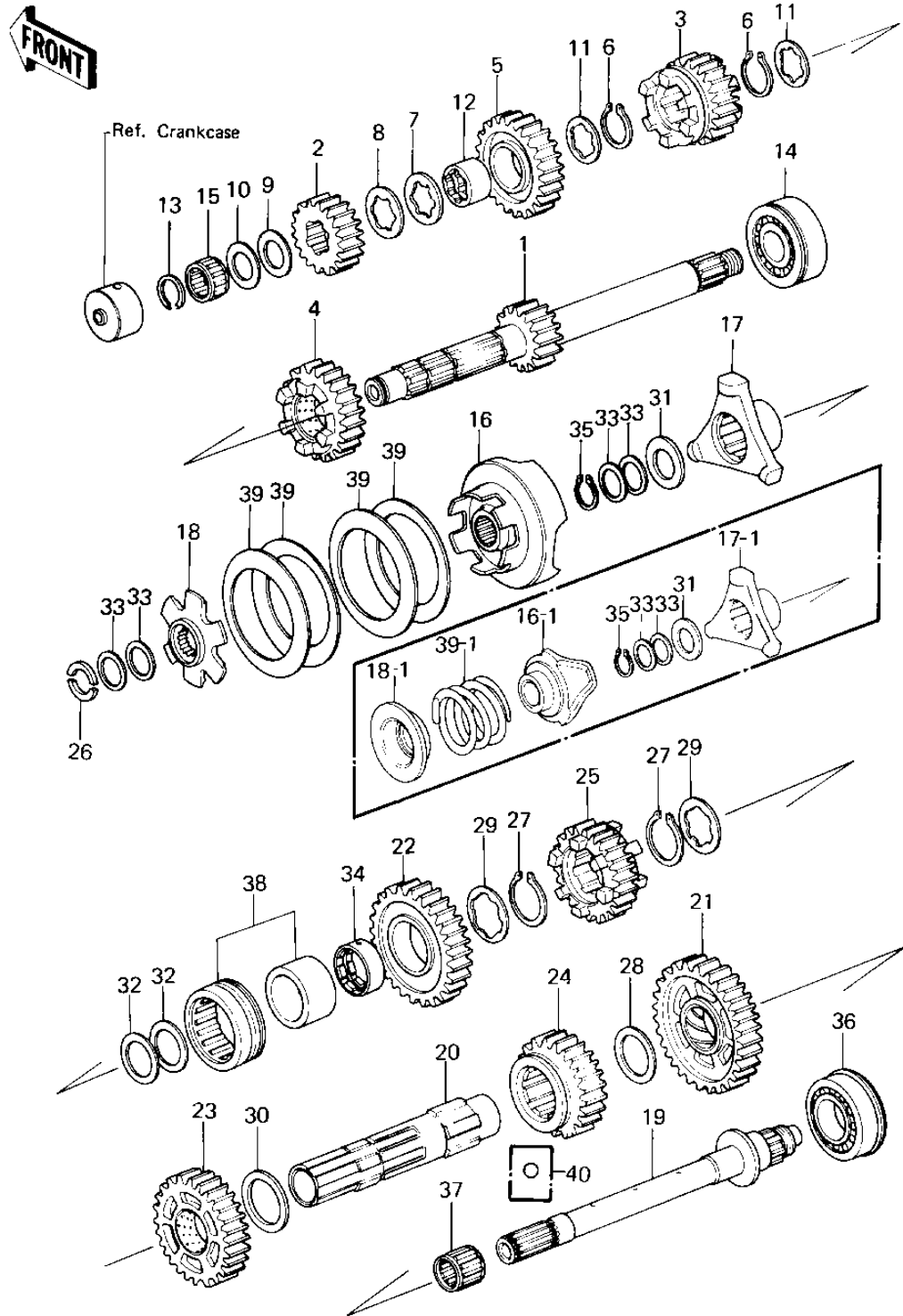

1981 KZ1300-A3 PARTS LIST

TRANSMISSION

ITEM NAME	PART NUMBER	QUANTITY
SHAFT,DRIVE (Ref # 1)	13127-1010	1
2ND GEAR,DRIVE SHAFT (Ref # 2)	13129-1096	1
3RD GEAR,DRIVE SHAFT (Ref # 3)	13129-1097	1
GEAR,INPUT 3RD,25T (Ref # 3)	13129-1256	1
4TH GEAR,DRIVE SHAFT (Ref # 4)	13129-1098	1
GEAR-INPUT TOP,29T (Ref # 5)	13129-1592	1
CIRCLIP 28MM (Ref # 6)	480J2800	2
WASHER,SPLINED,3.0T (Ref # 7)	92022-1098	1
WASHER,DRIVE TOP GEAR (Ref # 8)	92022-1099	1
SPACER (I.D=22 O.D=35 (Ref # 9)	92026-1020	1
WASHER,PLAIN,22MM (Ref # 10)	92022-212	1
WASHER,THRUST,26MM (Ref # 11)	92024-042	2
BUSHING,INPUT TOP GEA (Ref # 12)	92028-1302	1
CIRCLIP,25MM (Ref # 13)	92033-025	1
BEARING,BALL,5305NSH2 (Ref # 14)	92045-1028	1
BEARING,PK223013.8 (Ref # 15)	92046-031	1
CAM,DAMPER (Ref # 16)	13048-1002	1
CAM-DAMPER (Ref # 16-1)	13048-1011	1
FOLLOWER,CAM (Ref # 17)	13048-1003	1
CAM-DAMPER (Ref # 17-1)	13048-1010	1
HOLDER,SPRING (Ref # 18)	13091-1030	1
HOLDER,SPRING (Ref # 18-1)	13091-1091	1
SHAFT,DRIVEN,INNER (Ref # 19)	13128-1016	1
SHAFT,DRIVEN,OUTER (Ref # 20)	13128-1017	1
SHAFT-OUTPUT,OUTER (Ref # 20)	13128-1116	1
LOW GEAR,DRIVEN SHAFT (Ref # 21)	13129-1100	1
GEAR,OUTPUT LOW,39T (Ref # 21)	13129-1257	1
2ND GEAR,DRIVEN SHAFT (Ref # 22)	13129-1101	1
3RD GEAR,DRIVEN SHAFT (Ref # 23)	13129-1102	1

1981 KZ1300-A3 PARTS LIST

TRANSMISSION

ITEM NAME	PART NUMBER	QUANTITY
4TH GEAR,DRIVEN SHAFT (Ref # 24)	13129-1103	1
GEAR,OUTPUT 4TH,29T (Ref # 24)	13129-1258	1
TOP GEAR,DRIVEN SHAFT (Ref # 25)	13129-1104	1
GEAR-OUTPUT TOP,27T (Ref # 25)	13129-1593	1
RING,POSITON (Ref # 26)	14013-1001	2
CIRCLIP,36M/M (Ref # 27)	480J3600	2
WASHER,34.3X44X1.0 (Ref # 28)	92022-1100	1
WASHER,SPLINED,1.0T (Ref # 29)	92022-1101	2
WASHER,36.3X46X2.0 (Ref # 30)	92022-1102	1
WASHER,23.2X38X3.0 (Ref # 31)	92022-1103	1
SHIM,34.3X42X0.1 (Ref # 32)	92025-1002	AR
SHIM,34.3X42X0.3 (Ref # 32)	92025-1003	AR
SHIM,23.3X30.7X0.1 (Ref # 33)	92025-1004	AR
SHIM,23.3X30.7X0.3 (Ref # 33)	92025-1005	AR
BUSHING,OUTPUT 2ND GE (Ref # 34)	92028-1303	1
CIRCLIP,22.8M/M (Ref # 35)	92033-1021	1
BEARING,BALL,#3206 (Ref # 36)	92045-1018	1
BEARING,N,K23X28X24 (Ref # 37)	92046-1015	1
BEARING-NEEDLE (Ref # 38)	92046-1119	1
SPRING,DAMPER (Ref # 39)	92081-1089	4
SPRING,DAMPER (Ref # 39-1)	92081-1286	1
BALL STEEL 5/32' (Ref # 40)	600A0500	4