

1981 KZ1300-A3 PARTS DIAGRAM

FRONT MASTER CYLINDER

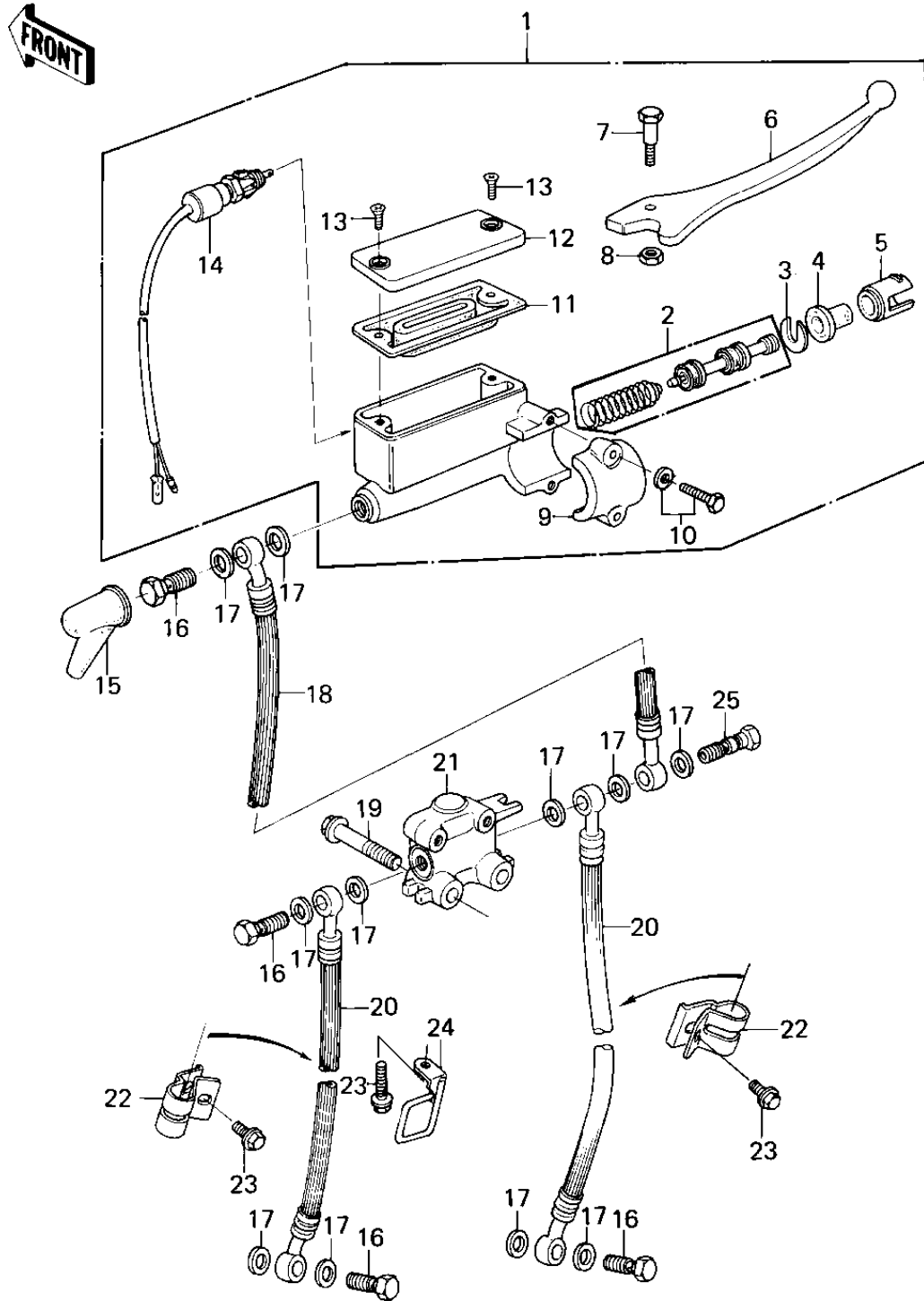

1981 KZ1300-A3 PARTS LIST

FRONT MASTER CYLINDER

ITEM NAME	PART NUMBER	QUANTITY
CYLINDER ASSY,FRONT (Ref # 1)	43015-1060	1
PISTON-COMP-BRAKE (Ref # 2)	43020-1023	1
STOPER,PISTON (Ref # 3)	43022-1001	1
DUST COVER (Ref # 4)	49016-1010	1
LINER,PISTON (Ref # 5)	14008-1007	1
LEVER,FRONT BRAKE (Ref # 6)	46092-1004	1
BOLT,CLUTCH LEV FITT (Ref # 7)	92001-1056	1
NUT 6MM (Ref # 8)	312B0600	1
HOLDER,MASTER CYLINDR (Ref # 9)	43034-1001	1
BOLT,HEX HEAD,6X25 (Ref # 10)	43033-003	2
DIAPHRAGM (Ref # 11)	43028-1008	1
CAP,OIL CUP (Ref # 12)	43026-1012	1
SCREW,COUNTERSUNK HED (Ref # 13)	92001-1055	2
SWITCH,BRAKE (Ref # 14)	27010-1028	1
BOOT,DUST (Ref # 15)	49006-1041	1
BOOT,DUST (Ref # 15)	49006-1041	1
BOLT,OIL,L=23 (Ref # 16)	92002-1888	4
WASHER-OIL BOLT (Ref # 17)	43067-001	11
HOSE,BRAKE (Ref # 18)	43059-1042	1
BOLT,FLANGED,8X45 (Ref # 19)	130G0845	2
HOSE-BRAKE,L=570 (Ref # 20)	43059-1175	2
JOINT,BRAKE (Ref # 21)	43061-1001	1
BRACKET,BRAKE HOSE (Ref # 22)	11034-1284	2
BOLT,FLANGED,6X8 (Ref # 23)	130B0608	3
BRACKET,SPEED CABLE (Ref # 24)	11034-1285	1
BOLT (Ref # 25)	92002-1909	1