

1981 KZ1300-A3 PARTS DIAGRAM

METERS

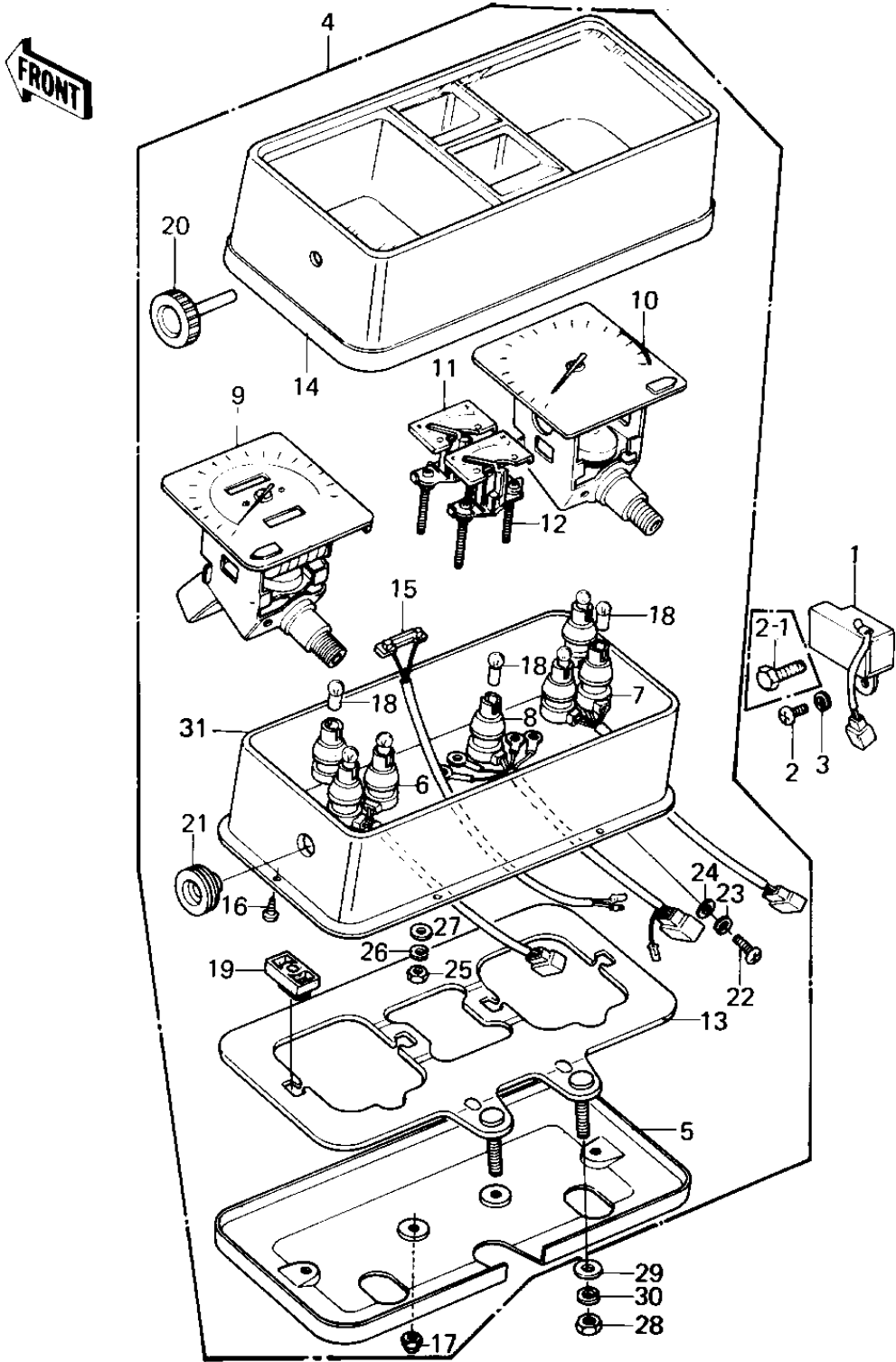

1981 KZ1300-A3 PARTS LIST

METERS

ITEM NAME	PART NUMBER	QUANTITY
REGULATOR,VOLTAGE (Ref # 1)	21066-1006	1
SCREW PAN HEAD 6X12 (Ref # 2)	220B0612	1
BOLT-UPSET,6X12 (Ref # 2-1)	112G0612	1
WASHER SPRING 6MM (Ref # 3)	461F0600	1
METER ASSY,MPH (Ref # 4)	25001-1299	1
METER ASSY,MPH (Ref # 4)	25001-1147	1
METER ASSY,MPH (Ref # 4)	25001-1147	1
25001-1148 (Canada) (Ref # 4)	25001-1088	1
METER ASSY,KPH (Canada) (Ref # 4)	25001-1148	1
COVER,METER,LOWER (Ref # 5)	14025-1098	1
SOCKET ASSY,SPEEDOMET (Ref # 6)	23008-1033	1
SOCKET ASSY,TACHOMETE (Ref # 7)	23008-1034	1
SOCKET ASSY,FUEL & TE (Ref # 8)	23008-1035	1
SPEEDOMETER ASSY,MPH (Ref # 9)	25005-1044	1
SPEEDOMETER UNIT,MPH (Ref # 9)	25005-1069	1
SPEEDOMETER UNIT,KPH (Canada) (Ref # 9)	25005-1051	1
TACHOMETER UNIT (Ref # 10)	25015-1037	1
METER,FUEL (Ref # 11)	28011-1003	1
METER,TEMPERATURE (Ref # 12)	28011-1007	1
METER,TEMPERATURE (Ref # 12)	28011-1007	1
BRACKET,METER (Ref # 13)	25008-1015	1
COVER,METER,UPPER (Ref # 14)	25023-1010	1
SENSOR,DISTANCE (Ref # 15)	27010-1032	1
SCREW,TAPPING (Ref # 16)	92008-012	6
NUT-CAP,5MM (Ref # 17)	322N0500	4
BULB 12V 3W (Ref # 18)	92069-018	7
DAMPER,METER BRACKET (Ref # 19)	92075-1140	4
KNOB,TRIP (Ref # 20)	92077-1008	1
SEAL,TRIP KNOB (Ref # 21)	92093-1029	1

1981 KZ1300-A3 PARTS LIST

METERS

ITEM NAME	PART NUMBER	QUANTITY
SCREW PAN HEAD 4X8 (Ref # 22)	220B0408	4
WASHER SPRING 4MM (Ref # 23)	461F0400	4
WASHER PLAIN 4MM (Ref # 24)	410B0400	4
NUT,4MM (Ref # 25)	311B0400	8
WASHER SPRING 4MM (Ref # 26)	461F0400	8
WASHER PLAIN 4MM (Ref # 27)	410B0400	4
NUT,8M/M (Ref # 28)	317B0800	2
WASHER PLAIN 8MM (Ref # 29)	411B0800	2
WASHER SPRING 8MM (Ref # 30)	461F0800	2
COVER,METER CASE (Ref # 31)	14025-1805	1