

1982 CSR PARTS DIAGRAM

TURN SIGNALS

F2730-0003

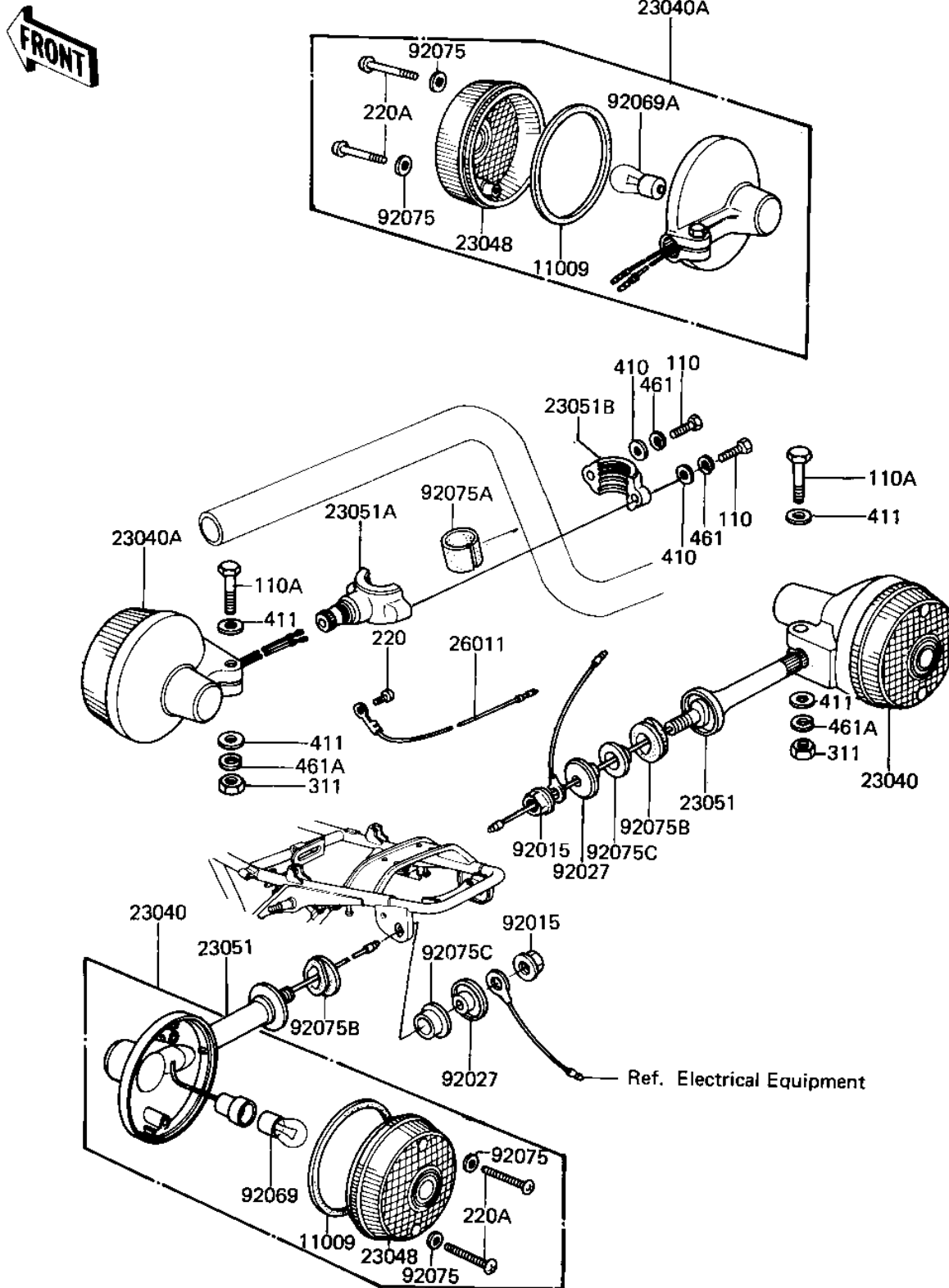

1982 CSR PARTS LIST

TURN SIGNALS

ITEM NAME	PART NUMBER	QUANTITY
GASKET-SIG LAMP LENS (Ref # 11009)	23050-003	4
LAMP,TURN SIGNAL (Ref # 23040)	23040-054	2
LAMP,FRNT,TURN SIGNAL (Ref # 23040A)	23040-1004	2
LENS,TURN SIGNAL LAMP (Ref # 23048)	23048-1001	4
BRACKET,TURN SIGNAL.L (Ref # 23051)	23051-053	2
BRACKET,FRNT TURN SIG (Ref # 23051A)	23051-1004	2
BRACKET,SIGNAL LAMP (Ref # 23051B)	23051-1013	2
WIRE-TURN SIGNAL LEAD (Ref # 26011)	26011-061	2
NUT,FLANGED,10MM (Ref # 92015)	92015-1428	2
COLLAR (Ref # 92027)	92027-147	2
BULB 12V 32CP (Ref # 92069)	92069-055	2
BULB,12V 23/8W (Ref # 92069A)	92069-060	2
WASHER-PLAIN,4MM (Ref # 92075)	23058-002	8
DAMPER RUBBER (Ref # 92075A)	23066-003	2
DAMPER RUBBER (Ref # 92075B)	92075-128	2
DAMPER RUBBER,SIG LM (Ref # 92075C)	92075-158	2
BOLT (Ref # 110)	110N0516	4
BOLT-UPSET (Ref # 110A)	112G0630	4
SCREW PAN HEAD 3X5 (Ref # 220)	220B0305A	2
SCREW-PAN HEAD,4X20 (Ref # 220A)	220E0420A	8
NUT 6MM (Ref # 311)	311B0600	4
WASHER-PLAIN,5MM (Ref # 410)	410D0500	4
WASHER PLAIN 6MM (Ref # 411)	411B0600	8
WASHER SPRING 5MM (Ref # 461)	461F0500	4
WASHER SPRING 6MM (Ref # 461A)	461F0600	4