

1969 Mach III PARTS DIAGRAM

KICKSTARTER MECHANISM ('69-'72 H1/A/B/C)

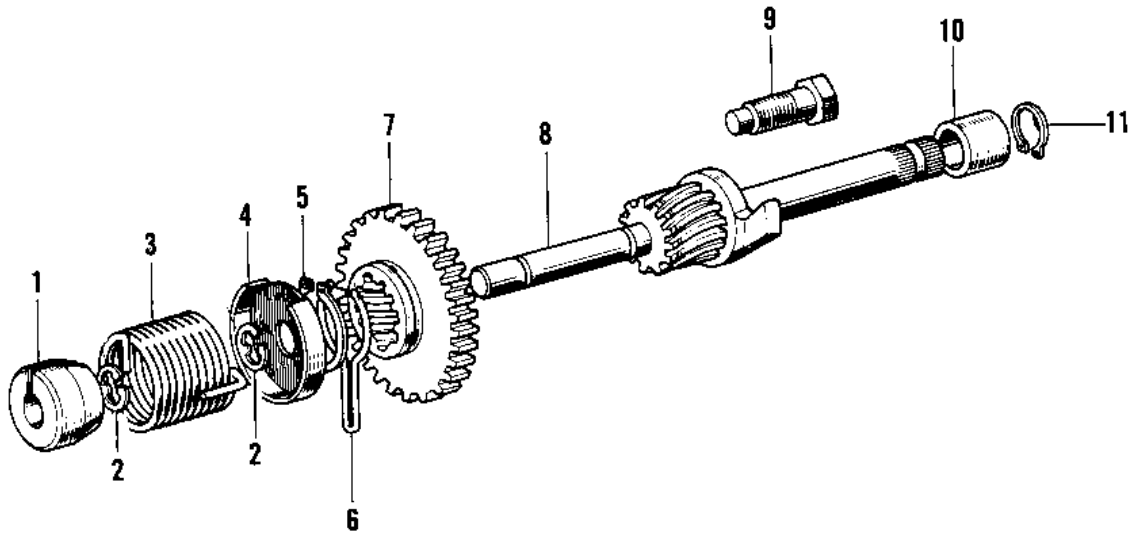
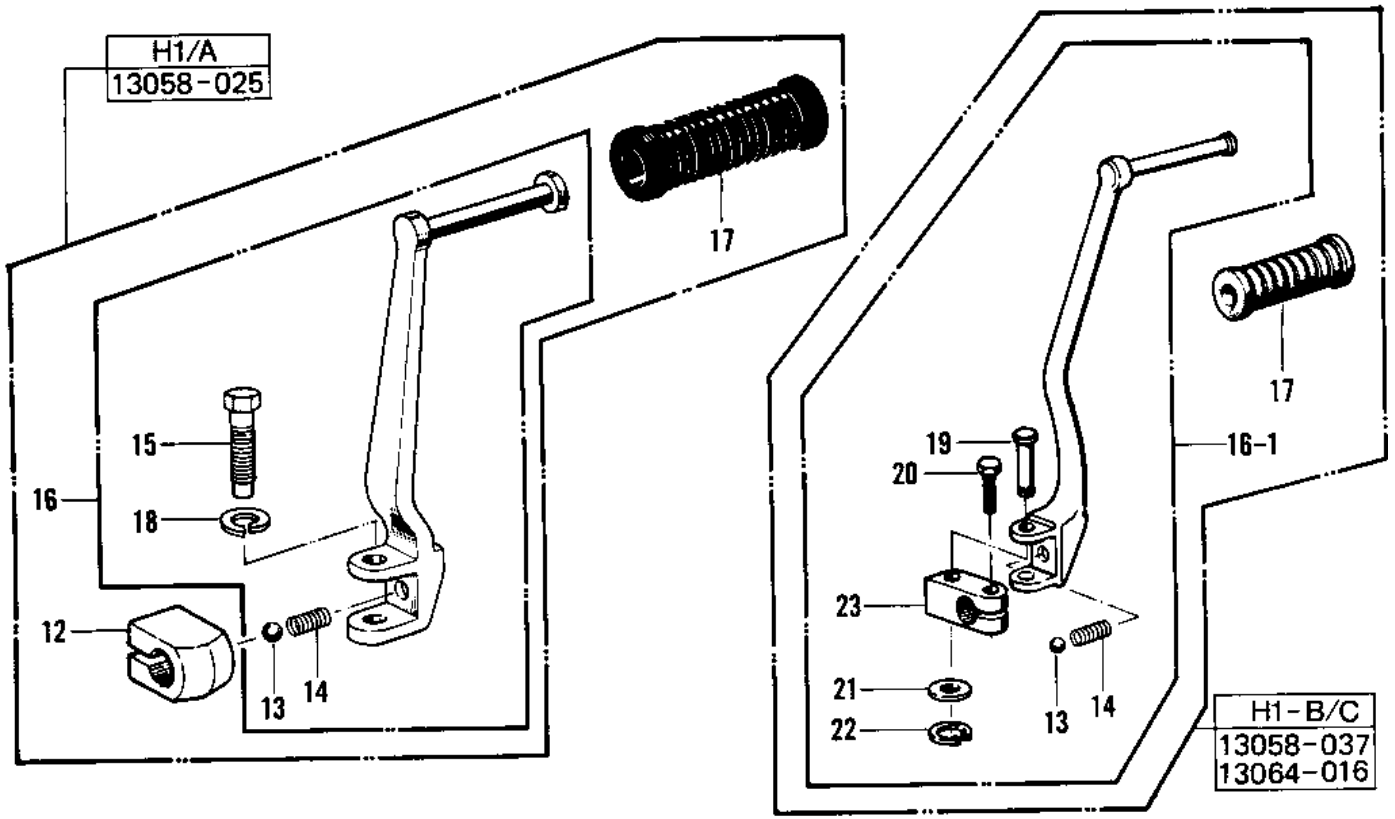

1969 Mach III PARTS LIST

KICKSTARTER MECHANISM ('69-'72 H1/A/B/C)

ITEM NAME	PART NUMBER	QUANTITY
GUIDE KICK SPRING (Ref # 1)	13070-001	1
CIRCLIP 10MM (Ref # 2)	482J0100	2
SPRING KICKSTARTER (Ref # 3)	92081-021	1
PLATE KICK GEAR HLDER (Ref # 4)	13071-003	1
CIRCLIP 26MM (Ref # 5)	480J2600	1
HOLDER KICK GEAR (Ref # 6)	13077-002	1
GEAR KICKSTARTER (Ref # 7)	13068-015	1
SHAFT ASY,KICKSTARTER (Ref # 8)	13245-009	1
SHAFT ASY,KICKSTARTER (Ref # 8)	13245-009	1
STOPPER KICKSTARTER (Ref # 9)	13072-006	1
BUSH (Ref # 10)	92028-072	1
CIRCLIP 16MM (Ref # 11)	480J1600	1
BOSS KICK PEDAL (Ref # 12)	13061-007	1
BALL STEEL 3/16' (Ref # 13)	600A0600	1
SPRING KICK PEDAL (Ref # 14)	92081-020	1
BOLT 10MM (Ref # 15)	92001-071	1
PEDAL,KICKSTARTER (Ref # 16)	13064-016	1
PEDAL,KICKSTARTER (Ref # 16-1)	13064-016	1
PEDAL,KICKSTARTER (Ref # 16-1)	13064-016	1
RUBBER KICK PEDAL (Ref # 17)	13063-004	1
WASHER-SPRING (Ref # 18)	92095-011	1
PIN-KICKSTARTER (Ref # 19)	92043-075	1
BOLT-KICK PEDAL (Ref # 20)	92001-101	1
WASHER PLAIN 8MM (Ref # 21)	410B0800	1
CIRCLIP 5MM (Ref # 22)	482K5000	1
BOSS-KICK PEDAL (Ref # 23)	13061-013	1