

1969 Mach III PARTS DIAGRAM

FENDERS (H1/A/C)

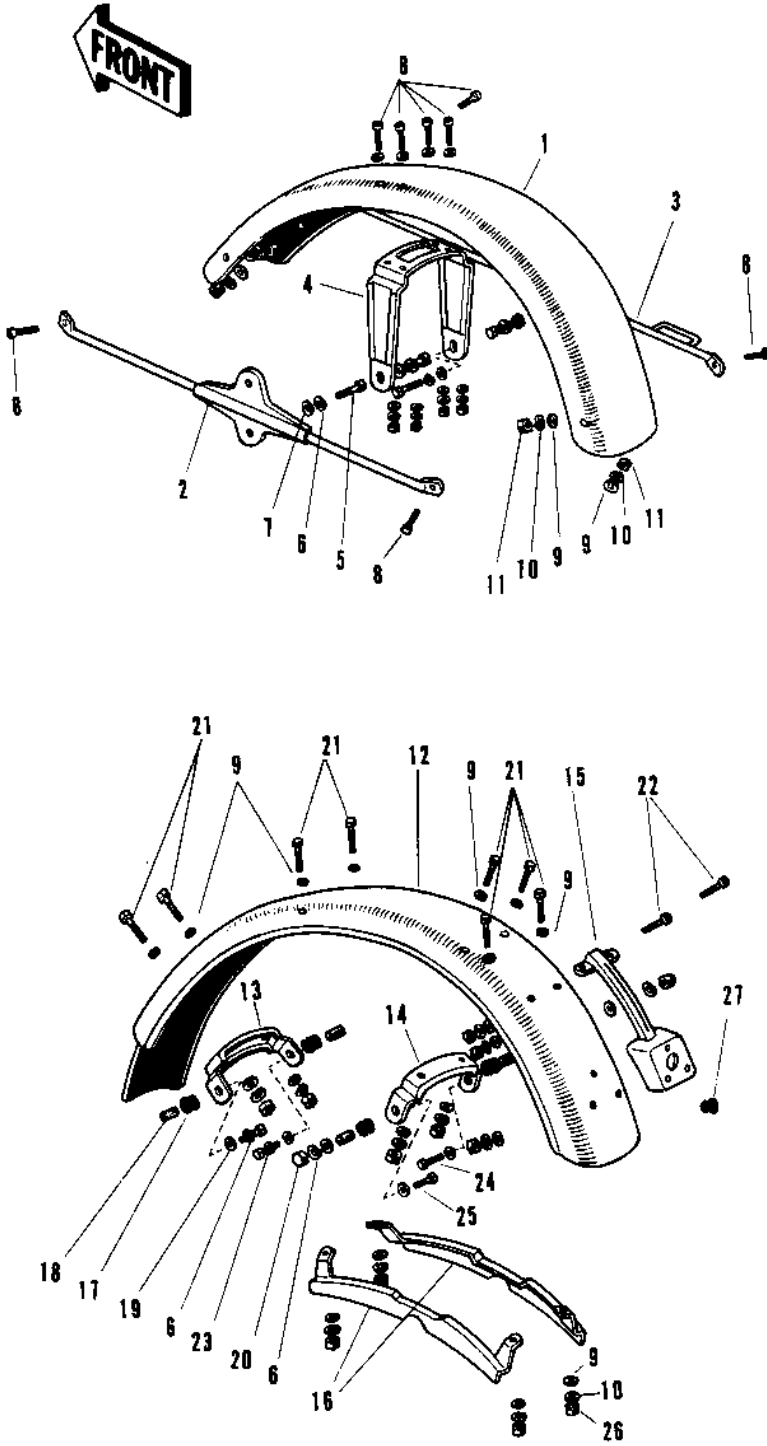

(H1/A

1969 Mach III PARTS LIST

FENDERS (H1/A/C)

ITEM NAME	PART NUMBER	QUANTITY
FENDER-FR (Ref # 1)	35004-036	1
STAY FRONT FENDER L.H (Ref # 2)	35011-018	1
STAY FRONT FENDER R.H (Ref # 3)	35011-017	1
BRACE FRONT FENDER (Ref # 4)	35009-012	1
BOLT-SMALL-UPSET,8X14 (Ref # 5)	115B0814	4
WASHER SPRING 8MM (Ref # 6)	461F0800	8
WASHER PLAIN 8MM (Ref # 7)	410B0800	4
SCREW PAN HEAD 6X12 (Ref # 8)	220E0612	8
WASHER PLAIN 6MM (Ref # 9)	411B0600	24
WASHER SPRING 6MM (Ref # 10)	461F0600	18
NUT 6MM (Ref # 11)	312B0600	8
FENDER-RR (Ref # 12)	35022-045	1
BRACKET REAR FENDER (Ref # 13)	35025-009	1
BRACKET REAR FENDER (Ref # 14)	35025-010	1
STAY TAIL LAMP (Ref # 15)	35031-004	1
SUPPORTER REAR FENDER (Ref # 16)	35034-007	2
DAMPER RUBB TANK FRNT (Ref # 17)	92075-019	4
SPACER FUEL TANK MONT (Ref # 18)	51065-001	4
WASHER,8X26X2.3 (Ref # 19)	92022-1564	4
NUT FUEL TANK FRONT (Ref # 20)	92020-007	2
BOLT-UPSET,6X12 (Ref # 21)	112G0612	8
SCREW PAN HEAD 6X12 (Ref # 22)	220B0612	2
BOLT-SMALL-UPSET,8X22 (Ref # 23)	115B0822	2
BOLT,10X45 (Ref # 24)	92001-1182	1
BOLT,10X45 (Ref # 24)	92001-1182	1
BOLT,8X55 (Ref # 25)	92001-1386	1
BOLT,8X55 (Ref # 25)	92001-1386	1
NUT 6MM (Ref # 26)	311B0600	10
PLUG RUBBER (Ref # 27)	92074-005	1