

# 1970 Mach III PARTS DIAGRAM

GEAR CHANGE MECHANISM ('73-'75 D/E/F & ')

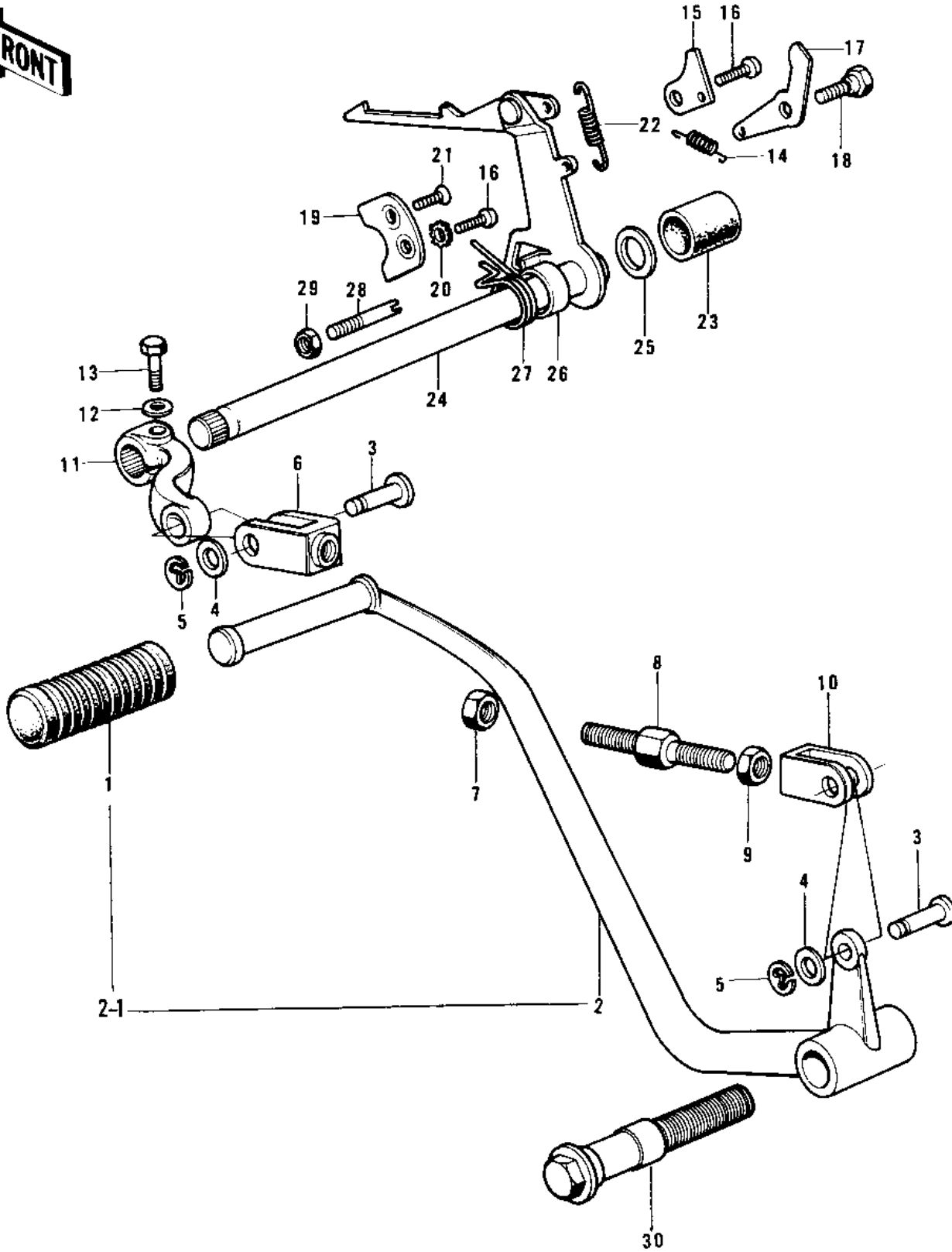

# 1970 Mach III PARTS LIST

GEAR CHANGE MECHANISM ('73-'75 D/E/F & ')

ITEM NAME	PART NUMBER	QUANTITY
RUBBER CHANGE PEDAL (Ref # 1)	13157-004	1
PEDAL ANY,GEAR CHANGE (Ref # 2)	13242-011	1
PEDAL ANY,GEAR CHANGE (Ref # 2-1)	13242-011	1
PIN (Ref # 3)	92043-069	2
WASHER,PLAIN (Ref # 4)	92022-1028	2
CIRCLIP 5MM (Ref # 5)	482K5000	2
CONNECTOR,B (Ref # 6)	13159-008	1
NUT,8MM (Ref # 7)	92017-010	1
BOLT,CHNG PEDAL JOINT (Ref # 8)	92003-115	1
NUT,8MM (Ref # 9)	318N0800	1
CONNECTOR,A (Ref # 10)	13159-007	1
LEVER-GEAR CHANGE (Ref # 11)	13158-011	1
WASHER SPRING 8MM (Ref # 12)	461F0800	1
BOLT,8X20 (Ref # 13)	115G0820	1
BOLT-SMALL-UPSET,8X22 (Ref # 13)	115B0822	1
SPRING,CHNG DRUM LEVR (Ref # 14)	92081-1045	1
PLATE CHANGE DRUM LEV (Ref # 15)	13170-004	1
SCREW PAN HEAD 6X16 (Ref # 16)	220B0616	2
LEVER GEAR CHNG DRUM (Ref # 17)	13168-012	1
BOLT,CHANGE DRUM LEVE (Ref # 18)	92150-1450	1
PLATE CHNG DRUM PSTON (Ref # 19)	13169-005	1
WASHER LOCK 6MM (Ref # 20)	464H0600	1
SCREW CNTSNK HD 6X16 (Ref # 21)	212B0616	1
SPRING,CHANGE LEVER (Ref # 22)	92144-1720	1
SPRING,CHANGE LEVER (Ref # 22)	92081-151	1
RUBBER CAP (Ref # 23)	13080-004	1
LEVER ASSY GEAR CHNG (Ref # 24)	13161-035	1
LEVER ASSY GEAR CHNG (Ref # 24)	13161-035	1
LEVER ASSY,CHANGE (Ref # 24)	13161-045	1

# 1970 Mach III PARTS LIST

GEAR CHANGE MECHANISM ('73-'75 D/E/F & ')

ITEM NAME	PART NUMBER	QUANTITY
SPACER (Ref # 25)	92026-068	1
COLLAR (Ref # 26)	92027-121	1
SPRING,TENTION (Ref # 27)	92081-1129	1
BOLT,RETURN SPRING (Ref # 28)	92001-1401	1
NUT 8MM (Ref # 29)	312B0800	1
BOLT,CHANGE PEDAL (Ref # 30)	92003-117	1
SHIM-KICK SHAFT,0.5T (Ref # 31)	92022-150	1
NUT,12MM (Ref # 32)	314G1200A	1