

1970 Mach III PARTS DIAGRAM

IGNITION/GENERATOR/REGULATOR (H1-D)

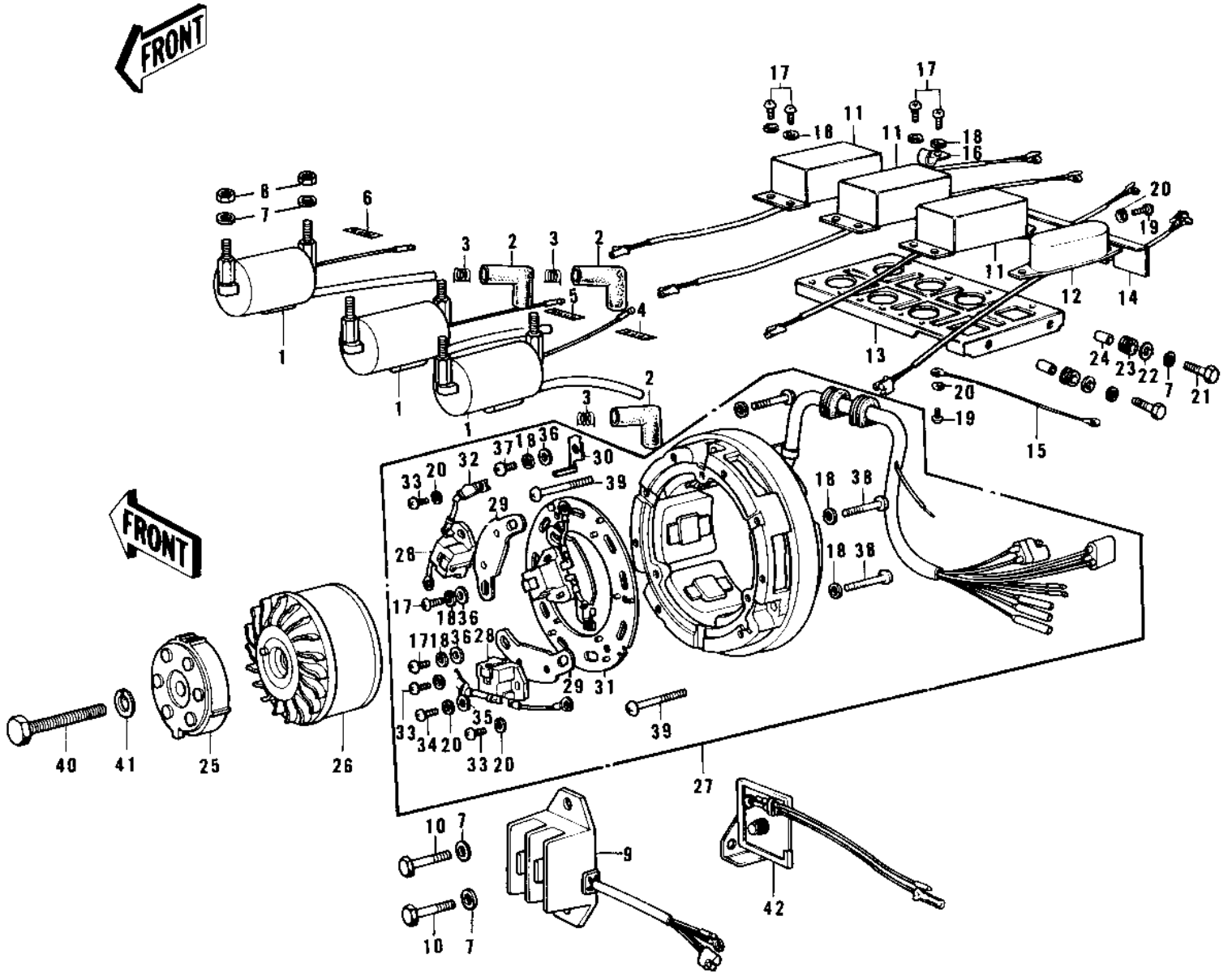

(H1-D)

1970 Mach III PARTS LIST

IGNITION/GENERATOR/REGULATOR (H1-D)

ITEM NAME	PART NUMBER	QUANTITY
COIL-IGNITION (Ref # 1)	21121-064	3
CAP SPARK PLUG (Ref # 2)	21130-009	3
SPRING-SPARK PLUG CAP (Ref # 3)	92101-001	3
LABEL,LEFT (Ref # 4)	21168-001	1
LABEL,CENTER (Ref # 5)	21168-002	1
LABEL,RIGHT (Ref # 6)	21168-003	1
WASHER SPRING 6MM (Ref # 7)	461F0600	12
NUT 6MM (Ref # 8)	311B0600	6
REGULATOR (Ref # 9)	21066-1036	1
BOLT-UPSET,6X16 (Ref # 10)	112G0616	2
IGNITION UNIT A (Ref # 11)	21119-016	3
IGNITION UNIT B (Ref # 12)	21120-006	1
PLATE,IGNITION UNIT (Ref # 13)	21155-005	1
PLATE (Ref # 14)	21155-004	1
WIRE-LEAD (Ref # 15)	21045-009	1
CLAMP-WIRE (Ref # 16)	21098-009	1
SCREW PAN HEAD 5X10 (Ref # 17)	220B0510	15
WASHER SPRING 5MM (Ref # 18)	461F0500	21
SCREW PAN HEAD 4X6 (Ref # 19)	220B0406	3
WASHER SPRING 4MM (Ref # 20)	461F0400	15
BOLT-UPSET (Ref # 21)	112G0618	4
WASHER 6.5X20X1.6T (Ref # 22)	92022-125	4
DAMPER RUBBER (Ref # 23)	92075-051	4
COLLAR (Ref # 24)	92027-103	4
ROTOR-S.G (Ref # 25)	21007-021	1
ROTOR (Ref # 26)	21007-024	1
YOKE ASSY (Ref # 27)	21076-015	1
PICK UP (Ref # 28)	21152-003	3
PLATE-PICK UP (Ref # 29)	21156-002	3

1970 Mach III PARTS LIST

IGNITION/GENERATOR/REGULATOR (H1-D)

ITEM NAME	PART NUMBER	QUANTITY
POINTER-IGN TIMING (Ref # 30)	21020-002	1
PLATE-YOKE (Ref # 31)	21155-002	1
CLAMP-LEAD WIRE (Ref # 32)	21098-008	3
SCREW PAN HEAD 4X8 (Ref # 33)	220B0408	6
SCREW PAN HEAD 4X10 (Ref # 34)	220B0410	6
WASHER PLAIN 4MM (Ref # 35)	410B0400	6
WASHER PLAIN 5MM (Ref # 36)	411B0500	9
SCREW PAN HEAD 5X12 (Ref # 37)	220B0512	3
SCREW-PAN-CROS (Ref # 38)	220B0535	3
SCREW-PAN-CROS (Ref # 39)	220B0540	3
BOLT FLANGED,8X70 (Ref # 40)	92001-1583	1
WASHER SPRING 8MM (Ref # 41)	461F0800	1
RECTIFIER (Ref # 42)	21061-014	1