

1967 Roadrunner PARTS DIAGRAM

IGNITION/GENERATOR (~E/NO: 909149)

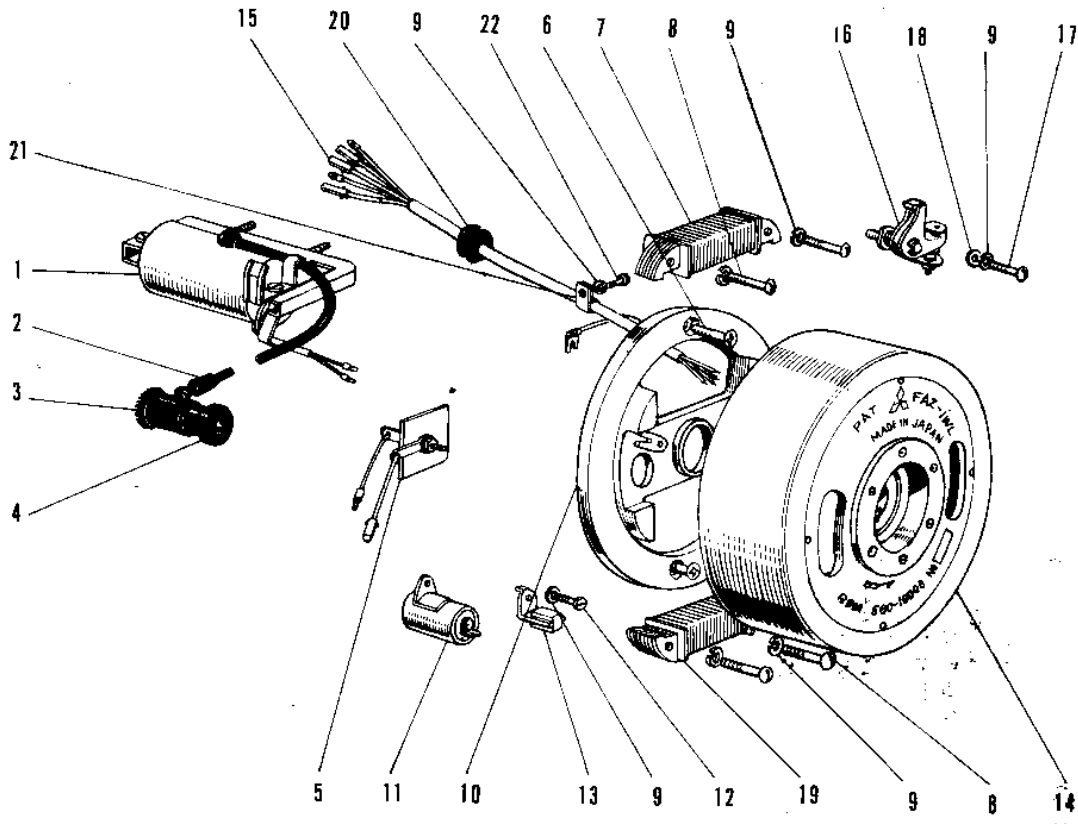

1967 Roadrunner PARTS LIST

IGNITION/GENERATOR (~E/NO: 909149)

ITEM NAME	PART NUMBER	QUANTITY
COIL IGNITION (Ref # 1)	21121-029	1
GROMMET (Ref # 2)	92071-517	1
CAP-SPARK PLUG (Ref # 3)	21130-016	1
GROMMET PLUG CAP A (Ref # 4)	21131-002	1
RECTIFIER (Ref # 5)	21061-5001	1
SCREW CNTSNK HD 6X14 (Ref # 6)	221B0614	2
UNAVAILABLE IN PRICE BOOK (Ref # 7~22)	211002-006	1
COIL LIGHTING (Ref # 7)	21047-004	1
SCREW PAN HEAD 4X24 (Ref # 8)	21022-003	1
SCREW PAN HEAD 4X25 (Ref # 8)	21022-001	1
WASHER SPRING 4MM (Ref # 9)	461F0400	4
BASE MAGNETO (Ref # 10)	21048-004	1
CONDENSER (Ref # 11)	21013-001	1
SCREW PAN HEAD 4X10 (Ref # 12)	220B0410	1
SCREW PAN HEAD 4X10 (Ref # 12)	220B0410	1
FELT OIL (Ref # 13)	21019-005	1
FLYWHEEL (Ref # 14)	21050-003	1
WIRING HARNESS MAG (Ref # 15)	21029-001	1
BREAKER ASSY CONTACT (Ref # 16)	21008-002	1
SCREW PAN HEAD 4X12 (Ref # 17)	21022-004	1
SCREW-PAN-CRSOSS,4X12 (Ref # 17)	220B0412	1
WASHER PLAIN 4MM (Ref # 18)	410B0400	1
COIL PRIMARY IGNITION (Ref # 19)	21049-003	1
GROMMET WIRING HARN (Ref # 20)	21017-002	1
CLAMP WIRING HARNESS (Ref # 21)	21037-002	1
SCREW PAN HEAD 4X6 (Ref # 22)	21022-010	1
SCREW PAN HEAD 4X6 (Ref # 22)	220B0406	1