

# 1981 KE175 PARTS DIAGRAM

KICKSTARTER MECHANISM ('80-'81 KE175-D2/

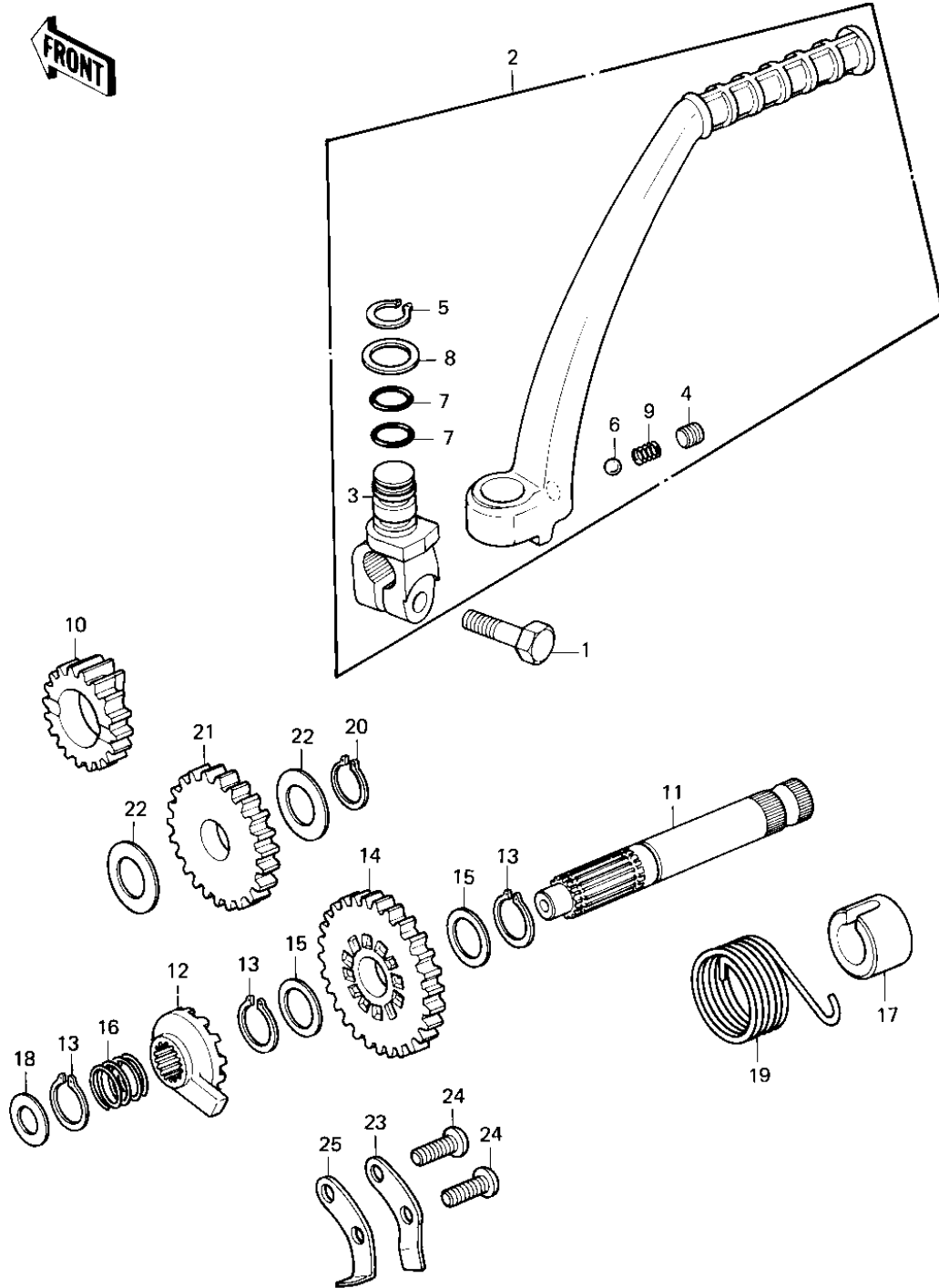

# 1981 KE175 PARTS LIST

KICKSTARTER MECHANISM ('80-'81 KE175-D2/

ITEM NAME	PART NUMBER	QUANTITY
BOLT-SMALL-UPSET 8X25 (Ref # 1)	115G0825	1
PEDAL ASSY,KICK (Ref # 2)	13064-1027	1
PEDAL ASSY,KICK (Ref # 2)	13064-1027	1
BOSS,KICK PEDAL (Ref # 3)	13061-5001	1
BOSS,KICK PEDAL (Ref # 3)	13061-5001	1
SCREW,8X8 (Ref # 4)	290Q0808	1
CIR CLIP (Ref # 5)	482K0100	1
BALL STEEL 1/4' (Ref # 6)	600A0800	1
"O" RING,12MM (Ref # 7)	670B2012	2
WASHER,PLAIN (Ref # 8)	92022-1019	1
SPRING KICK PEDAL (Ref # 9)	92081-020	1
PINION-KICKSTARTER (Ref # 10)	13075-006	1
SHAFT,KICK (Ref # 11)	13066-1006	1
RATCHET (Ref # 12)	13078-1001	1
CIRCLIP 16MM (Ref # 13)	480J1600	3
GEAR,KICKSTARTER,34T (Ref # 14)	59051-1010	1
WASHER,PLAIN (Ref # 15)	92022-315	2
SPRING,RATCHET (Ref # 16)	92081-122	1
GUIDE,KICK SPRING (Ref # 17)	13070-1007	1
WASHER,PLAIN (Ref # 18)	92022-269	1
SPRING,KICKSTARTER (Ref # 19)	92082-005	1
CIRCLIP 15MM (Ref # 20)	480J1500	1
GEAR,IDLE,29T (Ref # 21)	59051-1019	1
WASHER-PLAIN (Ref # 22)	92022-169	2
GUIDE,KICK (Ref # 23)	13206-1002	1
SCREW PAN HEAD 6X16 (Ref # 24)	220B0616	2
STOPPER,KICK (Ref # 25)	32085-1027	1