

# 1983 KE175 PARTS DIAGRAM

GEAR CHANGE MECHANISM ('82-'83 KE175-D4/

E1370-0008

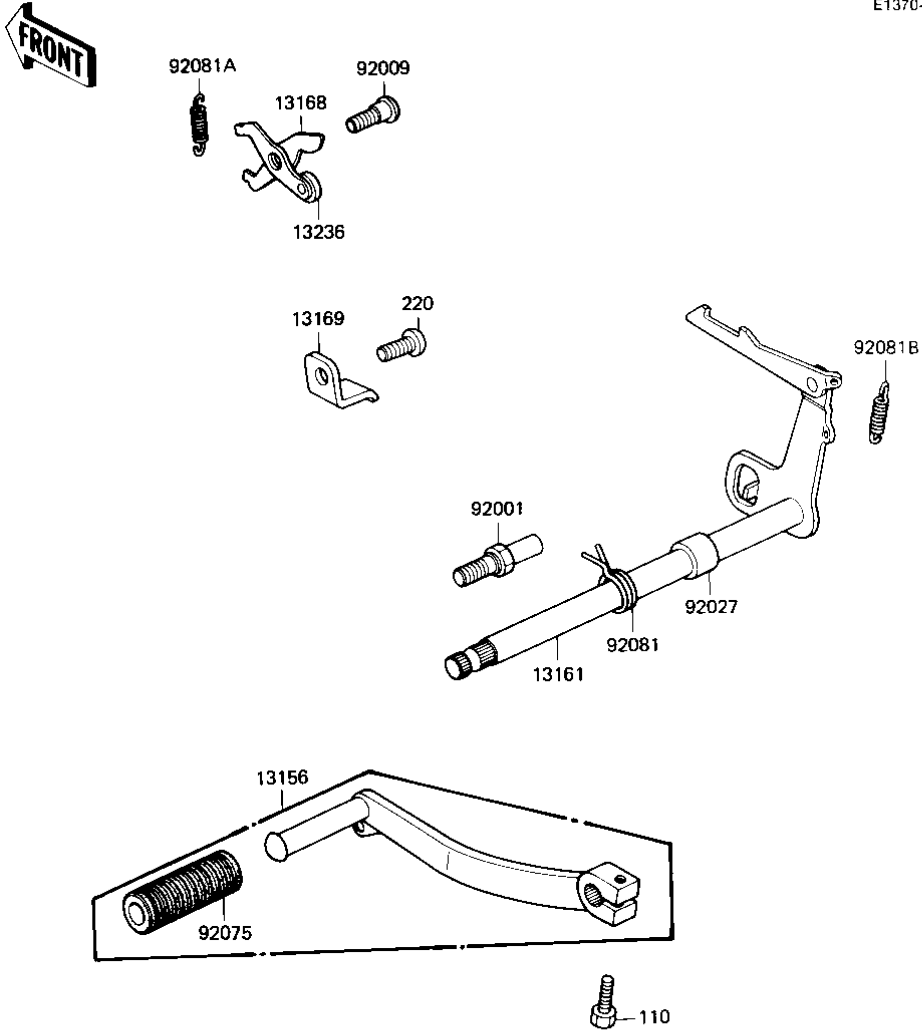

# 1983 KE175 PARTS LIST

GEAR CHANGE MECHANISM ('82-'83 KE175-D4/

ITEM NAME	PART NUMBER	QUANTITY
LEVER-ASSY-CHANGE,PED (Ref # 13156)	13242-1273	1
LEVER ASSY,GEAR CHANG (Ref # 13161)	13161-1017	1
LEVER,GEAR SET (Ref # 13168)	13168-1058	1
PLATE,GEAR CHANGE (Ref # 13169)	13169-1253	1
LEVER,NEUTRAL (Ref # 13236)	13236-1004	1
BOLT,RETURN SPRING (Ref # 92001)	92001-1401	1
SCREW-PAN HEAD (Ref # 92009)	92011-023	1
COLLAR (Ref # 92027)	92027-189	1
RUBBER CHANGE PEDAL (Ref # 92075)	13157-004	1
SPRING,TENTION (Ref # 92081)	92081-1129	1
SPRING,CHANGE LEVER (Ref # 92081A)	92081-1237	1
SPRING,GEAR CHANGE (Ref # 92081B)	92081-156	1
BOLT-UPSET,6X20 (Ref # 110)	112G0620	1
SCREW PAN HEAD 6X12 (Ref # 220)	220B0612	1