

1984 JS550 PARTS DIAGRAM

FUEL TANK (JS550-A1/A2)

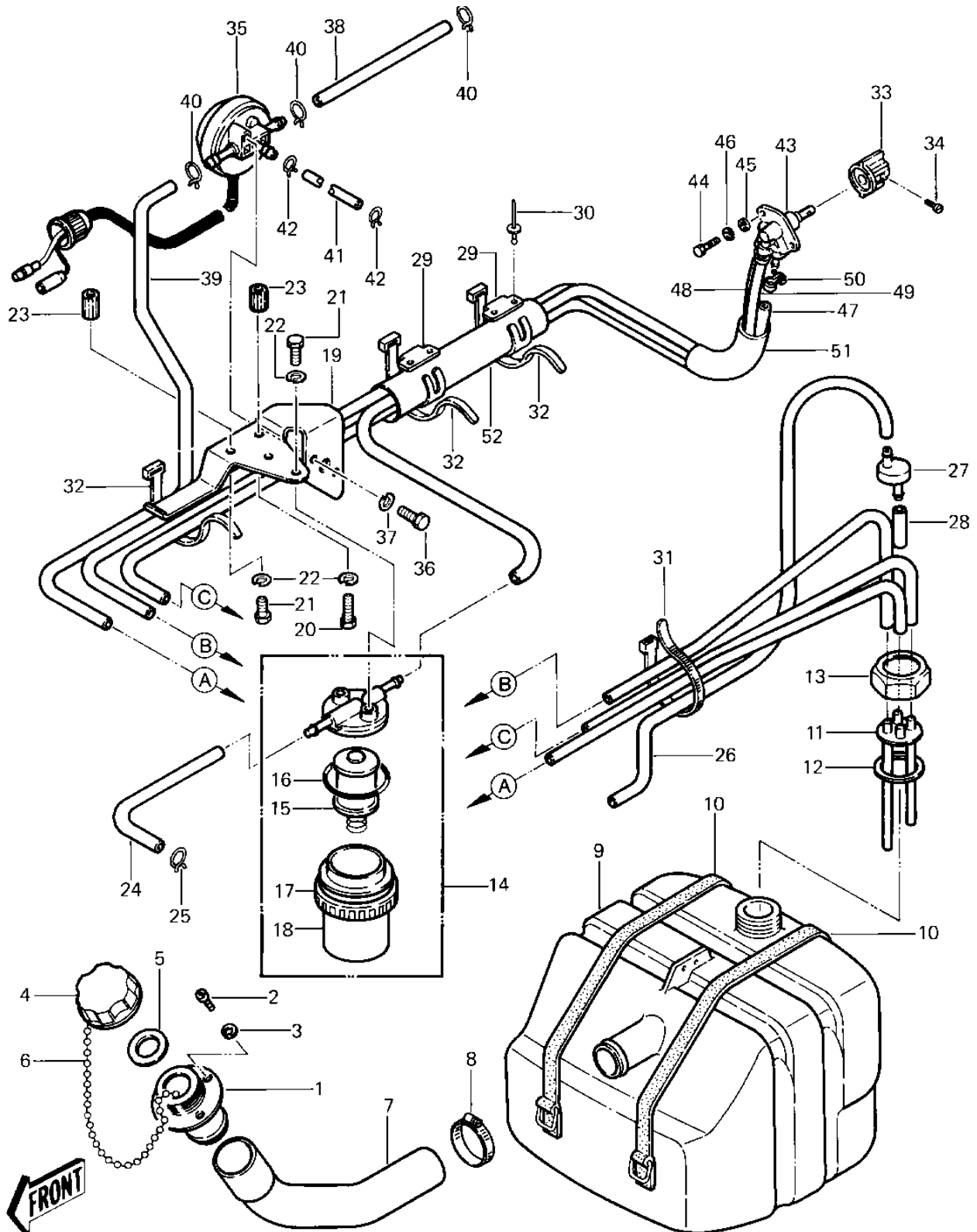

1984 JS550 PARTS LIST

FUEL TANK (JS550-A1/A2)

ITEM NAME	PART NUMBER	QUANTITY
FILLER,FUEL TANK (Ref # 1)	59231-3001	1
SCREW 0.16X0.5 (Ref # 2)	92011-562	4
WASHER (Ref # 3)	92022-563	4
CAP,FUEL TANK (Ref # 4)	51049-3001	1
GASKET,FUEL TANK CAP (Ref # 5)	11009-3020	1
CHAIN,COVER (Ref # 6)	92057-3704	1
HOSE,FUEL INLET,307.5 (Ref # 7)	92059-3020	1
HOSE CLAMP (Ref # 8)	92037-3009	1
TANK-FUEL (Ref # 9)	51004-3702	1
BAND,FUEL TANK (Ref # 10)	92072-521	2
OUTLET,FUEL (Ref # 11)	31064-3001	1
GASKET (Ref # 12)	92065-504	1
RETAINER (Ref # 13)	23072-501	1
FILTER-FUEL (Ref # 14)	49019-3701	1
FILTER,FUEL ELEMENT (Ref # 15)	14043-3701	1
"O" RING,FILTER BASE (Ref # 16)	92055-3006	1
NUT-RING,60MM (Ref # 17)	92015-3013	1
CUP,FUEL FILTER (Ref # 18)	51036-3701	1
BRACKET,FILTER (Ref # 19)	11034-3013	1
BOLT-UPSET,6X16 (Ref # 20)	112G0616	1
BOLT 6X12 (Ref # 21)	110R0612	3
WASHER-SPRING,6MM (Ref # 22)	461S0600	4
NUT, INSERT, 6MM (Ref # 23)	92015-3014	2
TUBE,6X10X200 (Ref # 24)	92059-3011	1
CLAMP,SPARK PLUG CAP (Ref # 25)	92037-1173	1
TUBE,FUEL,6X10X940 (Ref # 26)	92059-3025	1
VALVE,RELIEF (Ref # 27)	49057-3001	1
TUBE,FUEL,5.8X12.2X55 (Ref # 28)	92059-3026	1
CLAMP,TUBE (Ref # 29)	92037-3005	2

1984 JS550 PARTS LIST

FUEL TANK (JS550-A1/A2)

ITEM NAME	PART NUMBER	QUANTITY
RIVET-FUEL LINE CLAMP (Ref # 30)	59281-505	4
BAND,SHORT (Ref # 31)	92072-030	1
BAND,MIDDLE (Ref # 32)	92072-031	2
KNOB,COCK (Ref # 33)	92077-503	1
SCREW-PAN-CROS (Ref # 34)	220R0408	1
VALVE ASSY,SOLENOID (Ref # 35)	49116-3001	1
BOLT 6X14 (Ref # 36)	110R0614	2
WASHER-SPRING,6MM (Ref # 37)	461S0600	2
TUBE,CARB/VALVE (Ref # 38)	92059-3036	1
TUBE,VALVE/TANK (Ref # 39)	92059-3037	1
CLAMP,SPARK PLUG CAP (Ref # 40)	92037-1173	3
TUBE,VALVE/CARB (Ref # 41)	92059-3038	1
CLAMP,7.3MM (Ref # 42)	92037-3025	2
TAP-ASSY,FUEL (Ref # 43)	51023-3705	1
BOLT,5X12 (Ref # 44)	110R0512A	2
WASHER (Ref # 45)	411S0500	2
WASHER-SPRING,5MM (Ref # 46)	461S0500	2
TUBE,6X1300 (Ref # 47)	92059-552	1
TUBE,6X1300,RESERVE (Ref # 48)	92059-553	1
TUBE,6X10X960 (Ref # 49)	92059-3007	1
CLAMP (Ref # 50)	92037-551	3
TUBE,GUARD (Ref # 51)	92059-3008	1
TUBE,VINYL,22X350 (Ref # 52)	92059-3018	1